

JUSTRITE

CATALOG No. 589

SECOND EDITION

PRICES SUBJECT TO CHANGE WITHOUT NOTICE

IMPORTANT
NEW PRICES, EFFECTIVE
NOVEMBER 16, 1959
PLEASE USE NEW PRICE
LIST ENCLOSED

CONTENTS

PAGE

2. HEAVY DUTY, HIGH POWER SEARCHLIGHTS
3. "YELLOW-FLASH"[®] 12 VOLT and 6 VOLT
LANTERNS for GENERAL USE
4. "LIGHT-STICKS"[®] and LANTERNS
for MAINTENANCE and PROTECTION
5. ELECTRIC HEADLIGHTS
6. INSPECTORS LIGHTS and LANTERNS
7. "TWIN-BULB"[®] RAILROAD LANTERNS
8. TABLE OF OPERATING INFORMATION
for MINIATURE LAMPS and BATTERIES
9. ACCESSORIES and PARTS
for ELECTRIC LIGHTS and LANTERNS
10. SAFETY HEADLIGHTS
SPECIAL PURPOSE LIGHTS and LANTERNS
11. SAFETY LIGHTS and LANTERNS
12. OILY WASTE, PLUNGER and LAB. CANS
IMPROVED BENCH and DRIP CANS
13. SAFETY CANS, TYPE I and TYPE II
14. CARBIDE HEAD LAMPS
15. CARBIDE CAP and HAND LAMPS

Our **53rd. Year**
Established 1906

Model Number SPECIFICATIONS List Price Each
Less Batteries

JUSTRITE "PENDRAGON"® LANTERNS

Are smaller, give more light and cost less to operate than other comparable lanterns. Fit in box 5½" x 10" x 10". Headpiece mounted to turn up or down. Case holds three lantern batteries. Carrying Handle has a steel ring on front and one on back so a carrying strap can be easily attached.

PENDRAGON "SEALED-BEAM" LANTERN

2401-4 With 1.25 Amp. Sealed Beam Lamp No. 4547. Use three 6 volt lantern batteries in parallel for 6 volt circuit. With double throw switch. One in shipping carton. Wt. 3½ lbs. \$21.95

PENDRAGON, REFLECTOR LANTERN

2404-3 With 4½" precision designed vacuum metalized Reflector No. 20,628 with adjustable Lamp socket No. 20,631 for Candelabra D.C. Bayonet Base Lamp. With one 6 volt Lamp Bulb No. 1553 having two filaments, one for powerful beam and one for flood light. Use three lantern batteries in parallel for 6 volt circuit. With double throw switch. One in shipping carton. Wt. 3¼ lbs. \$22.95
20,159 Adjustable Shoulder Strap, 50 in., with clips \$1.40

PENDRAGON WITH OUTSIDE CONNECTION

2401-5 Pendragon Nos. 2401-4 and 2404-3 with plug in socket on side of case for an outside auxiliary 6 volt circuit for Marker Lights. One in shipping carton. Wt. 3½ lbs. \$24.95

PENDRAGON "EMERGENCY" LANTERN

For use in case of power failure. When case is plugged into a circuit lantern lights if circuit fails. Write for information.

BRACKET TO HOLD "PENDRAGON"

20,213 Adjustable Bracket mounted to revolve, to hold Nos. 2401 or 2404. Lantern cannot be locked in bracket. One in shipping carton, weight 1¼ lbs. \$4.80
20,214 Bracket designed to lock lantern. Padlock not furnished. One in shipping carton, weight 1¼ lbs. 5.40

PENDRAGON STORAGE

BATTERY LANTERN

Pendragon Lantern No. 2404-3 with 6 volt 6 amp. hr. lead acid storage battery with trickle-charger, with cord with plug; all mounted on a tray for easy inspection and servicing. Plug cord in any 110-120 volt A.C. circuit to recharge.

2404-9 With Double Filament (spot or flood) Lamp No. 1554 in Reflector No. 20,628 with socket No. 20,631
One in shipping carton. Wt. 6 lbs.
20,023 "Non-Spill" lead-acid, 3 cell, Storage Battery, 6 volt 6 amp. hrs. Rechargeable.

JUSTRITE "INTERCEPTOR"® LANTERNS

Large Headpiece mounted to turn back or forward on battery case with "fold down" handles. Made of heavy gauge steel coated to resist rust and painted with long wearing "Catalyst" enamel. Insulation is treated to resist moisture and battery leakage. Switch on headpiece. Fits in space 4½" x 5¼" x 6½". Use one 6 volt lantern battery.

2411-1 With Sealed Beam Lamp No. 4546. One in shipping carton. Wt. 1¾ lbs. \$7.95

2411-6 With 4½" precision designed, vacuum metalized Reflector No. 20,634 with one prefocused Lamp No. PR 13. One in shipping carton. Wt. 1½ lbs. \$8.45



2401-4



2404-3

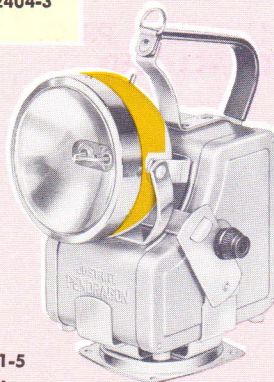

2401-5
IN
BRACKET
NO. 20,214

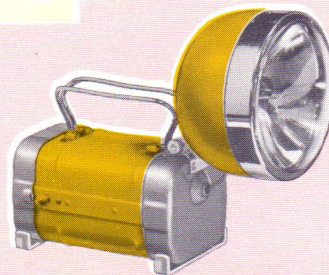
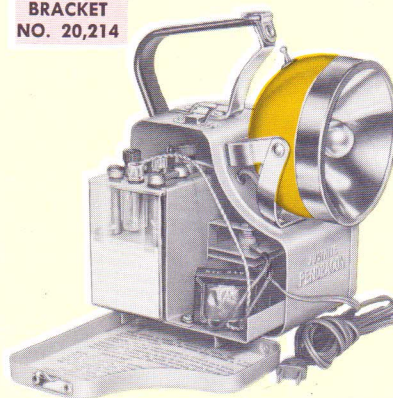

2411-1

DESCRIPTION

JUSTRITE "PENDRAGON"® LANTERNS ENTIRELY NEW, ENTIRELY DIFFERENT

An entirely new Portable Searchlight for industrial use. Smaller than other searchlights of equal power. Made of heavy gauge steel coated to resist rust and painted with "lamp silver" catalyst enamel. **Battery Case designed to hold three Lantern Batteries.** Handle is mounted so searchlight carries easily regardless of the number of batteries in case. Large headpiece is mounted in Double Bracket on battery case to turn up or down. A Toggle Switch is conveniently located on the headpiece. Headpiece will take either a Sealed Beam Lamp or a 4½" Reflector.

With 4½" precision designed vacuum metalized Reflector adjustable sockets can be furnished to hold a miniature screw or bayonet base lamp, or a candelabra screw or bayonet base lamp.

For ordinary use, use Three 6 volt Lantern (dry) Batteries making contact on the 6 volt, parallel wired, Contact Insulator Plate. Two batteries can be used but will not last proportionately as long. One battery can be used but will last a short time only if drain is over .5 amp.

For 12 volt circuit, Contact Insulator Plate can be furnished which has series wired contacts (on the back of the plate wired for 6 volts), and uses Two Lantern Batteries. A third battery can be carried as a spare or placed in the circuit to produce 18 volts, for special applications.

PENDRAGON STORAGE

BATTERY LANTERN

The Pendragon equipped with a storage battery and charger makes an ideal lantern. Not only is it cheaper to operate than the lantern equipped with dry cells but it gives more light. The battery can be recharged without removing it from the lantern by plugging cord attached to charger into any 110-120 volt "A-C" outlet.

LAMPS, ACCESSORIES AND PARTS, see Pages 8 & 9

MINIATURE SCREW BASE LAMPS		
20,245	No. 502, .15 Amp. 6 Volts . .	\$0.17
20,248	No. 27, .30 Amp. 6 Volts17
20,251	No. 425, .50 Amp. 6 Volts . .	.17

SEALED BEAM LAMPS		
20,254	No. 4546, .5 Amp. 6 Volts . .	2.50
20,257	No. 4547, 1.25 A. 6 V.	2.85

DBL. FIL., 6 VOLT LAMPS		
20,263	1.0 amp. for dry batteries . .	1.25
20,264	0.7 amp. for storage batteries	1.25

ACCESSORIES AND PARTS		
20,079	Insulator Plate for 2401, 2404	2.00
20,082	Case Cover for 2401, 2404 . .	1.80
20,628	4½" Reflector with Bushing for Adj. Lamp Socket. . .	2.40
20,631	Adjustable Socket for D. C. Candel. Bay Base Lamp . .	1.00
20,634	4½" Reflector designed for Miniature Lamp	2.20
20,635	Cup with spring to hold prefocused Lamp in reflector	.20
20,638	Cup with socket to hold Min. Sc. Base Lamp in refl. . .	.20

JUSTRITE "INTERCEPTOR"® LANTERNS

Convenient and powerful hand lights. Large Headpiece will take Sealed Beam Lamp or a 4½" Reflector. Battery Case holds one 6 volt lantern battery. With 4½" precision designed vacuum metalized reflector uses prefocused lamp No. PR 13.

DESCRIPTION

"YELLOW-FLASH" V-12 SEARCHLIGHT

The newest and most useful light made. Case designed to use 8 flashlight batteries arranged to give 12 volts, or to use one 6 volt lantern battery. Reflector designed to use a miniature screw base or Prefocused lamp.

For an intensely white powerful beam use 8 flashlight batteries to produce 12 volts and Tubular Lamp No. 965 which gives 6.3 spherical candlepower; more than 2½ times as much as any lamp suitable for use with one lantern battery.

For a brilliant long range spot beam, use reflector with a holder with a coiled spring, and use Prefocused Lamp No. PR 13 or PR 17 with one 6 volt lantern battery.

For regular hand lantern beam with one 6 volt lantern battery use reflector with holder containing min. sc. base socket. Use miniature screw base Lamp Bulb No. 27 for general use; No. 425 for brighter light but less battery life; No. 502 used by the railroads for long battery life.

LAMPS—LIGHT BULBS, see pages 8 & 9
PREFOCUSED LAMPS

No. PR17 Lamp .3 amp. for 4 cells or one 6 volt lantern battery...	\$0.20
No. PR13 Lamp .5 amp. for 4 cells or one 6 volt lantern battery...	.20
MINIATURE SCREW BASE LAMPS	
No. 407 Flashing Lamp .30 amp. for any 6 volt circuit.....	.27
No. 502 Lamp .15 amp. for 4 cells or one 6 volt lantern battery...	.17
No. 27 Lamp .30 amp. for 4 cells or one 6 volt lantern battery...	.17
No. 425 Lamp .5 amp. for 4 cells or one 6 volt lantern battery...	.17
No. 965 Lamp .5 amp. for 8 cells ..	.25

JUSTRITE 6-V. MIDGET SEARCHLIGHT

Headpiece same as on JUSTRITE No. 2209 but battery case is shorter so that four size D flashlight batteries may be used instead of eight. Any of the 6 volt lamp bulbs suitable for use in the No. 2209 can be used in the same way in the No. 2305. 12 volt Lamp Bulb No. 965 cannot be used.

Instead of the folding handles on the No. 2209, the No. 2305 has a finger ring type handle 2½" wide, which folds down against back of case, making the light easy to pack as well as easy to use.

SETS OF TWO LIGHTS
ONE RED AND ONE WHITE

For highway protection and to work efficiently, two lights are absolutely necessary; one to give a powerful white light and one to give a flashing red light. The white light is used to light up immediate surroundings, identify objects in the distance and in case of trouble to give light to find the causes and to make repairs. The red light is placed to mark obstructions and give warning to approaching traffic. On vacation and in camp the red light should be used to mark danger points. Place near any obstruction, pier or hazard to mark location for easy identification. Compact handy sets can be made up as follows:

"TROUBLE TWINS" LIGHT SET	
No. 2305-1 Searchlight . . .	\$4.15
No. 2305-4 Blinking Bm. Lt.	5.15
"WORK & WARNING" LIGHT SET	
No. 2305-1 Searchlight . . .	\$4.15
No. 2301-3 Lighthse. Lantn.	4.25

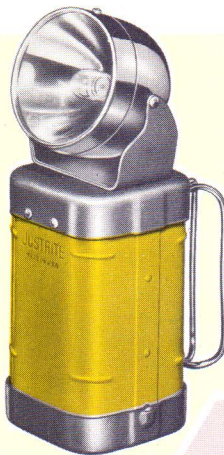

2209-1

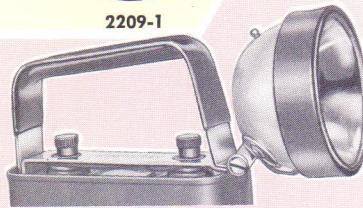

2434-3
20,019



2299-0



2305-1

2305-1



2301-3

2301-3

Model Number

SPECIFICATIONS

List Price Each Less Batteries

"YELLOW-FLASH" V-12 SEARCHLIGHT, 12 VOLT, CONVERTS TO 6 VOLT

Fits in space 3¼" x 3¼" x 8". Has 2¾" precision designed reflector in headpiece mounted to turn in bracket on battery case having "fold down" handles. Finished in polished chrome and long wearing "catalyst" enamel. Insulation, designed to resist moisture and battery leakage, and may be taken out and cleaned. Switch on battery case. With one 12 volt tubular Lamp No. 965. Use 8 flashlight batteries.

2209-1 One in display ctn. Std. pkg. 12, wt. 18 lbs. \$4.95

JUSTRITE "SADDLE-LIGHT" NO. 2434-3

Consists of 3¼" headpiece and insulated carrying handle mounted on steel plate which fits and "saddles" down on the two binding posts of any steel clad "double-six" six volt battery. Use a prefocused lamp or a miniature screw base lamp. Finished in chrome and "catalyst" enamel. Without battery. With two lamps, one No. PR 13 and one No. 1403.

One in ship. ctn. Std. pkg. 12, wt. 12 lbs. . . \$4.95
"Double six", 6 volt steel clad battery. . . . 2.76

JUSTRITE FISHERMAN'S LANTERN, 6-V.

Similar to the Yellow Flash Searchlight but designed especially to meet the needs of sportsmen. Finished in chrome and two pleasing shades of long wearing green catalyst enamel. Use one 6 volt battery. Furnished with one prefocused lamp No. PR 13.

One in display ctn. Std. pkg. 12, wt. 18 lbs. \$4.95

JUSTRITE V-6 MIDGET SEARCHLIGHT

Fits in space 3" x 3¼" x 6". Has 2¾" reflector in headpiece mounted to turn in bracket on battery case having "fold down" finger ring 2½" wide. Finished in polished chrome and long wearing "catalyst" enamel, baked on. Insulation designed to prevent shorts and treated to resist moisture and battery leakage.

Furnished with one Prefocused Lamp No. PR 13. Use four size "D" cells.

One in display ctn. Std. pkg. 12, wt. 12 lbs. \$4.15

JUSTRITE "BLINKING-BEAM" LIGHT

Midget Searchlight No. 2305-1, but with a transparent Red Disc to color the light beam and with a .3 amp. Flashing Bulb No. 407 (Justrite Part No. 20,099) which flashes an average of about 80 flashes a min.

Furnished with one spare lamp. One in ship. ctn. Std. pkg. 12, wt. 12 lbs. . . \$5.15

JUSTRITE "LIGHTHOUSE" 6 VOLT WARNING LANTERN

Should be in every car in case of an emergency or trouble on the road; in every camp as it will mark an area or path or mark a dock.

Has two conical reflectors one above the other held apart by a clear red cylindrical globe; gives light in all directions. Finished in long wearing "catalyst" enamel, baked on. Use 4 size "D" flashlight batteries. Furnished with No. 407 Flashing Lamp Bulb to produce a brilliant red flashing, warning or marker light.

One in ship. ctn. Std. pkg. 12, wt. 11 lbs. . . . \$4.25

Model Number	SPECIFICATIONS	List Price Each Less Batteries	DESCRIPTION
	LIGHT-STICK® Nos. 2106 and 2105 NEW IMPROVED FLASHLIGHT. Use four size "D" batteries. Has lucite lens over reflector in housing mounted to turn in bracket on cover of 1½" x 3" x 5½" battery case, with belt clip and finger ring. Switch on battery case cover. Use a .30 amp. lamp for general use, a .50 amp. lamp for brightest light and a .15 amp. lamp for long battery life. Finished in lamp silver catalyst enamel, baked on.		JUSTRITE INDUSTRIAL "LIGHT-STICK"® The more convenient money saving flashlight; a new type. The Light-Stick is a four cell flashlight that will fit the pocket, clip on the belt, or can be carried by the finger ring. It fits in a box 2½" x 3" x 8½". It will not roll and can be placed on a table to shine light diagonally under the table. It is the finest, most convenient "repair light" you can use. The four cell "Light-Stick" with .30 amp. lamp gives about 2½ times as much light as the conventional two cell flashlight with .50 amp. lamp. It costs less to operate because while there are twice as many cells in it they burn about 2½ times as long. The saving amounts to about one battery for each four hours of use. (See table of operating information on page 8).
2106-4	With 2¾" vacuum metalized reflector for use with prefocused lamp or miniature screw base lamp. Furnished with one pref. lamp No. PR 17 and with one min. sc. base lamp No. 27. One in ship. ctn. Std. pkg. 12, wt. 12 lbs....	\$6.60	
2105-4	With 2½" vacuum metalized reflector for use with miniature screw base lamp only. With rubber lens collar which will hold an auxiliary lens. Furnished with two No. 27 lamps. One in ship. ctn. Std. pkg. 12, wt. 10 lbs....	5.40	
2105-6	The No. 2105-4 but with headpiece stamped "Bell System"	5.40	

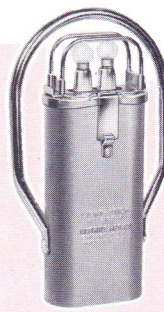
	JUSTRITE "TWIN-BULB LIGHT-STICK" NO. 2151 Made of steel painted with "lamp silver" long wearing catalyst enamel, baked on. Battery Case holds four size D cells, producing 6 volt circuit. Two lamps in focusing sockets are mounted on a slide on the cover so that either lamp lights when moved to the center of the cover. Lamps are protected by wire guard. Has bail handle. Packs in space 1¾" x 4¾" x 7¾". Furnished with two lamps, one No. 27 and one No. 502.		
2151-1	One in ship. ctn. Std. pkg. 12, wt. 8 lbs....		2151-1

LAMPS—LIGHT BULBS, see Pages 8 & 9
ACCESSORIES AND PARTS, see Page 9

	JUSTRITE "VEST-POCKET LIGHT-STICK" NO. 2155 About ¾" diam., 5¼" long. Battery Case high impact strength yellow plastic. Lamp holder clear plastic designed to give a strong beam from end and light from the side so user can identify objects around him. Pocket Clip is the switch; light cannot go on when clipped in pocket. Furnished with one No. 243 Lamp.		
2155-1	One in cardbd. bx. Std. pkg. 12, wt. 1¼ lbs.	\$1.98	2155
2155-2	The No. 2155-1 but with two "Energizer" electronic type batteries.		
	One in cardbd. bx. Std. pkg. 12, wt. 2 lbs.	2.45	
20,011	"Energizer" electronic type Battery, size "AA". Use two.....	List price each .22	
20,224	No. 243 Lamp (bulb TL-3) 2.33 V., .27 A.	.17	
20,156	Adj. Lanyard (with screw with eye).....	.40	

JUSTRITE "TWIN-BULB" LIGHT-STICK" NO. 2151
A new pocket lantern with two 6 volt lamps, either one instantly available. Should the lighted lamp fail the other lamp is moved to the center of the cover in a matter of seconds where it is lighted. This is a very convenient pocket hand light with an emergency feature which is almost a necessity in certain situations. Gives more light and costs less to operate than a two cell flashlight.

	JUSTRITE "TWIN-BULB" HAND LANTERN NO. 2142-6 Has two light bulbs protected by a lucite cover, either one instantly lighted when moved by switch lever to focal point of 3½" reflector. Has bail type handle. Flood light and beam at same time from either bulb. Lantern mounted to turn up or down. Use one 6 volt lantern battery. With two No. 27 Lamp Bulbs.		
2142-6	One in ship. ctn. Std. pkg. 12, wt. 30 lbs....	\$6.80	2142-6
20,590	Auxiliary Reflector 7" diam. fits on headpiece to give stronger beam.....	2.00	
	COVER, A.A.R. COLORS, FOR 9/16" LAMP BULB Fits down over either lamp bulb to color all light from that lamp only. They are color fast, absorb very little light and can be removed and reused at will.		
20,37*	*2 Red, *3 Yellow, *4 Green, *5 Blue.....	.20	

JUSTRITE "VEST-POCKET LIGHT-STICK" NO. 2155
A small pocket light which is very convenient and economical to operate. Uses the new "Energizer" Batteries No. 1015 developed for radio and electronic applications. This battery is very efficient and the hours of burning life are greatly increased over that of other size "AA" cells (17/32" diam., 1-7/8" long).

JUSTRITE "TWIN-BULB" HAND LANTERN, ALL PURPOSE TYPE, 6 VOLT
An ideal light for outdoor use such as around camp or farm. Justrite Twin-Bulb feature not only gives the necessary amount of side light to see nearby objects, but at the same time also gives a beam to pick up distant objects. Use one 6 volt lantern battery and light bulb No. 27 for general use. The other bulb can be No. 425 for brighter light, or No. 502 for longer battery life. The Twin-Bulb feature is also a safety feature. Should one bulb fail the other bulb is always instantly available so that the user is not without light at a time when light might be necessary. A plastic tubular shaped colored cover can be pushed down over either lamp bulb and colors the light from that lamp; easily removed.

DESCRIPTION

Model Number

SPECIFICATIONS

List Price Each Less Batteries

JUSTRITE SUPER SPORT-LIGHT NO. 1903

A super power light to wear on the forehead and have both hands free. Place battery case on belt. Gives all the light you need.

12 Volt Power. Use 8 flashlight batteries in series to produce 12 volts and gas filled light bulb No. 965 to get an intensely brilliant white darkness-penetrating light. Ideal for camping and for use in the woods.

6 Volt Economy. Use one 6 volt lantern battery with miniature screw base Lamp No. 27 for general use or No. 502 used by the Railroads for longer battery life.

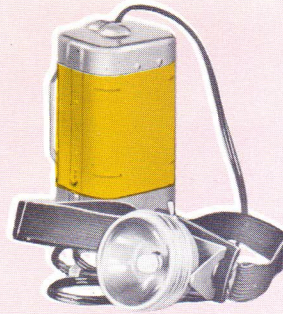

1903-6

JUSTRITE SUPER SPORT-LIGHT, 12 V. HEADLIGHT WITH BATTERY CASE

Use 8 size D cells in series to produce 12 volts, and gas filled light bulb No. 965 for brilliant white light. Use one 6 volt lantern battery and light bulb No. 27 for general use, No. 425 for brighter light and No. 502 for longer battery life. Has 2½" headlamp with headband on 18 gauge "Twinflex" 50" replaceable cord to 3" x 3" x 5" battery case with belt loops.

Furnished with one tubular Lamp No. 965.

1903-6 One in ship. ctn. Std. pkg. 12, wt. 18 lbs... \$5.45

JUSTRITE SPORT-LIGHT NO. 1904

An ideal sport light. Headlamp is generally worn on head but may be worn on arm, chest or leg. Use No. 425 or No. 27 Lamp. Battery case worn on belt or carried in pocket. Both headlamp and battery case are light weight and do not interfere with arm or head action. Used extensively in surf casting and in winter sports. Just the thing for outdoor work at night in the garden or around the house. Uses four size "D" cells.



1904-4

JUSTRITE SPORT-LIGHT, 6 VOLT HEADLIGHT WITH BATTERY CASE

Has 2½" reflector in focusing lens ring on reflector housing. Has 1½" x 3" x 5½" steel battery case with belt clip. Use four size D cells. With one Min. Sc. Base Lamp 425.

1904-4 One in ship ctn. Std. pkg. 12, wt. 13 lbs... \$4.60

JUSTRITE HEADLAMP ASSEMBLIES HEADLIGHTS WITHOUT BATTERY CASES FOR USE WITH 6 VOLT CIRCUITS

Headpiece with reflector, headband and 18 gauge Twinflex 50" cord with terminals.

1903-2 Has 3" Reflector and No. PR 13 Lamp Bulb. One in ship. ctn. Std. pkg. 12, wt. 8 lbs... \$4.30

1904-2 Has 2½" Reflector and No. 425 Lamp Bulb. One in ship. ctn. Std. pkg. 12, wt. 6 lbs... 2.95

JUSTRITE "EAGLE EYE"® HEADLIGHTS

Light in weight and extremely powerful. Gives intense spot beam from precision designed 3" vacuum metalized reflector when used with pre-focused Lamp No. PR 13. Switch conveniently located on reflector bracket. Reflector covered with polished Lucite Lens sealed on. Entire headpiece weighs only 5¼ ounces.

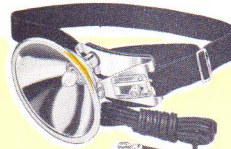

1911-2

JUSTRITE "EAGLE EYE"® HEADLIGHTS

Light weight, easy to use and adjust. Switch conveniently located on reflector bracket. Powerful sharp spot beam from pre-focused lamp in 3" reflector with Lucite Lens, can be adjusted up or down. Has 18 gauge Twinflex cord 50" long with terminals. Has strong elastic headband. Furnished with or without battery case.

"EAGLE EYE" WITHOUT BATTERY CASE
Headlamp Assembly only, as above, without battery case or holder. With one Lamp No. PR 13 for 6 volts.

1911-2 One in ship. ctn. Std. pkg. 12, wt. 6 lbs... \$3.30

"EAGLE EYE" WITH CASE FOR 4 CELLS
Headlight as above, with 1½" x 3" x 5½" Battery Case made of steel, coated to prevent rusting. Holds four size "D" cells to produce 6 volts. With one Lamp No. PR 13.

1911-4 One in ship. ctn. Std. pkg. 12, wt. 11 lbs... \$4.25

LAMPS — LIGHT BULBS, see Pages 8 & 9

PREFOCUSED LAMPS

No. PR 17 Lamp .3 amp. for 4 cells or one lantern battery.....	\$.20
No. PR 13 Lamp .5 amp. for 4 cells or one lantern battery.....	.20
No. PR 12 Lamp .5 amp. for 5 cells	.20
MINIATURE SCREW BASE LAMPS	
No. 365 Lamp .5 amp. for 3 cells..	.17
No. 605 Lamp .5 amp. for 5 cells..	.17
No. 502 Lamp .15 amp. for 4 cells or one lantern battery.....	.17
No. 27 Lamp .30 amp. for 4 cells or one lantern battery.....	.17
No. 425 Lamp .5 amp. for 4 cells or one lantern battery.....	.17
No. 965 Lamp .5 amp. for 8 cells or 2 lantern batteries in series	.25
No. 407 Flashing Lamp .30 amp. for any 6 volt circuit.....	.27

JUSTRITE DOUBLE PURPOSE DUALITES

Small, convenient hand lanterns, any one of which can be changed into a headlight in a matter of seconds. The lamp is worn on the forehead and the battery case can be attached to the belt or carried in pocket, leaving both hands free. Excellent for sportsmen; freedom of hands is a must for protection. Headband and cord are folded away in battery case when not in use. Converts from hand lantern to headlight without changing connections. An unusual and very popular light available in two sizes. Carrying handles are rigid and strong; engineered to give plenty of hand room. Uses size "D" cells.

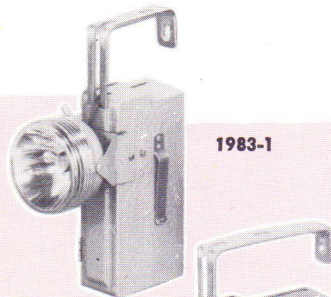

1983-1

JUSTRITE DOUBLE PURPOSE "DUALITE" Combination headlight and handlight.

Use size D flashlight cells. Has headpiece on front of battery case. Headpiece may be removed and worn on head without changing connections. Headband and cord attached to headpiece are packed in battery case. Carrying handle pushes down against case when not in use.

1983-1 2½" headpiece on 3 cell case 1½" x 3" x 6". With one miniature screw base Lamp No. 365. One in ship. ctn. Std. pkg. 12, wt. 18 lbs... \$6.45

1989-1 3¼" headpiece on 5 cell case 1½" x 4½" x 6". With one miniature screw base Lamp No. 605. One in ship. ctn. Std. pkg. 12, wt. 26 lbs... 8.45

1989-1

KNOCKS DANGER OUT OF DARKNESS

for railroads, utilities, industrials

Model Number	SPECIFICATIONS	List Price Each Less Batteries
	JUSTRITE "SADDLE-LIGHT" NO. 2434 Consists of headpiece and insulated carrying handle mounted on steel plate which fits and "saddles" down on the two binding posts of any steel clad "double-six" six volt battery. Battery not included, order separately.	
2434-4	With 4½" precision reflector. With double filament lamp for flood light or beam. One in shipping carton, weight 1¼ lbs....	\$10.45
2434-6	With Sealed Beam Lamp No. 4546. One in shipping carton, weight 1½ lbs....	8.95
2434-3	With 3" precision reflector. Use prefocused or min. sc. base lamp. With one No. PR 13 Lamp and one No. 1403 Lamp for flood light. One in shipping carton, weight 1 lb.....	4.95
20,019	"Double Six" 6 volt steel clad battery....	2.76
20,159	Adjustable Shoulder Strap, 50 in., with clips	\$1.40



2434-4

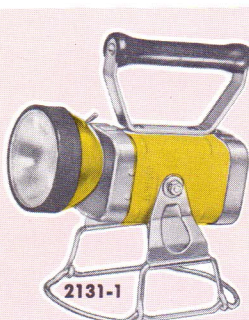

2131-1



2121-1

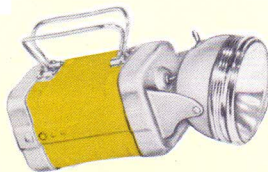

2219-2

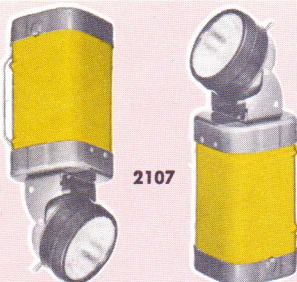

2107



1903-5

JUSTRITE INSPECTOR LANTERN NO. 2131

Has 3" reflector in headpiece on end of battery case mounted on stand which turns to allow easy carrying under arm. With two lamp bulbs, one to give a beam, the other a flood light.

2131-1 One in ship. ctn. Std. pkg. 12, wt. 20 lbs.... \$7.50

JUSTRITE "DOUBLE HEADER" LANTERN

Use one 6 volt lantern battery. Has two headpieces, each with 2½" reflector, switch and rubber lens collar, rigidly fixed on end of battery case mounted to turn up or down on steel wire stand. Furnished with two lamps; one headpiece has lamp with a long filament for a flood light; the other has lamp No. 27 for a powerful spot beam.

2121-1 One in ship. ctn. Std. pkg. 12, wt. 24 lbs... \$8.80

JUSTRITE INDUSTRIAL HAND LIGHT

Fits in space 3⅜" x 3⅜" x 8¼". Has 3" precision reflector in headpiece mounted to turn in bracket on battery case having "fold down" handles. Finished in long wearing enamel. Use one 6 volt lantern battery. Furnished with one No. 27 Lamp.

2219-2 One in ship. ctn. Std. pkg. 12, wt. 20 lbs.... \$5.40

JUSTRITE BELT LIGHT NO. 2107

WEAR WITH HEADPIECE DOWN OR UP Without handles and with 2½" reflector. Has loops for 2¼" belt, placed so that light is held firm against body. Has honeycomb lens in rubber lens collar. Furnished without belt. With one No. 27 Lamp.

2107-6 One in ship. ctn. Std. pkg. 12, wt. 17 lbs... \$4.95
5-809 Heavy Canvas Belt to hold Belt Light.... .52

JUSTRITE INDUSTRIAL HEADLIGHT

Use one 6 volt lantern battery and light bulb No. 27 for general use, No. 425 for brighter light and No. 502 for longer battery life. Has 2½" headlamp with headband on 18 gauge "Twinflex" 50" replaceable cord to 3" x 3" x 5" battery case with belt loops. With honeycomb lens in rubber lens collar over clear lens. With one light bulb No. 27.

1903-5 One in ship. ctn. Std. pkg. 12, wt. 18 lbs... \$5.95

JUSTRITE INSPECTORS LANTERNS

Designed to illuminate any given target with light bright enough and large enough to quickly discover any defects or trouble, so that repairs can be quickly made and a minimum amount of time lost. Extensively used by Railroads, by Utilities and by nearly every company in maintenance and inspection.

LONG WEARING

Made of finest materials, guaranteed finest workmanship. Design permits easy removal of parts to clean, repair and replace.

BATTERY CASE

Square type, made of steel coated to protect against rust, finished in high grade, long wearing catalyz enamel. Nos. 2107 and 1903 have belt loops for 2¼" belt. Nos. 2121 and 2131 take one lantern battery and have holder for spare bulb.

REFLECTORS

are vacuum metalized and are 4½", 3", 2¾" or 2½" in diam. (Sealed Beam Lamp No. 4546 can be used in place of a 4½" reflector.) The 4½" reflector can be furnished to hold a miniature or candelabra, screw or bayonet base lamp. The 4½" and 2¾" reflectors will take a prefocused or a miniature screw base lamp by changing the "cup" in the bushing on the back of the reflector. The 2½" reflector is designed for use with miniature screw base lamps only.

LAMPS AND LENSES

With a lamp with a concentrated filament use a clear lens for a powerful "spot" beam. If beam is to be spread over an area use a lens with a honeycomb or similar pattern although it will absorb some light. A lamp with a long double filament will spread the light from the reflector and a clear glass lens can be used to give more light on the target. Remember that when a circle of light one foot in diam. is spread over a circle 4 feet in diam., the intensity of that light drops to 1/16 of the intensity of the light on the one foot circle, even though the distance from lantern to target remains the same.

HANDLES

on Nos. 2121 and 2131 are wood, turned to give firm grip, mounted so they cannot turn in steel support firmly attached to battery case. Handles on No. 2219-2 fold down against battery case.

GUARDS

Nos. 2121 and 2131 have steel wire oblong base fastened with metal stampings to battery case so that lantern swivels to point up or down.

INDUSTRIAL HAND LIGHT

has many uses. It is economical to operate and is a time saver; speeds up transportation, journal boxes serviced more quickly. When beam is spread by a "pointex" glass lens it lights up a larger area.

JUSTRITE INDUSTRIAL HEADLIGHT

Speeds up transportation, journal boxes serviced more quickly. Has same characteristics as hand light but headpiece, worn on head, chest or leg, is connected to battery case by means of a conductor cord. Battery case has belt loops.

LONG WEARING

Made of finest materials, guaranteed finest workmanship. Design permits removal and replacement of parts. **JUSTRITE LANTERNS CAN BE REPAIRED.**

BATTERY CASE

Will not trap moisture. Made of steel coated inside and out to protect against rust. Holder for spare lamps in cover. Painted with catalyst enamel; the longest wearing paint. Use 6 volt lantern (dry) battery or rechargeable storage battery.

CIRCUIT AND INSULATION

Circuit is completely brass. Insulation will not absorb moisture.

HANDLE-BAIL

Heavy aluminum tubing, insulated against heat, cold and high voltage, with vinylite. Shape of handle allows lantern to be held near center of gravity giving perfect balance

REFLECTOR

Brass, highly polished, chrome plated. Diameter of parabola 3 1/2". **Lighted Lamp is always in the center of the reflector.** One Lamp gives floodlight completely around circle, lighting objects 17 1/2 degrees back of the lantern. The other Lamp gives a spot large enough to find and read car numbers, also a floodlight completely around circle, lighting objects 10 degrees back of the lantern. (Reflectors on "Flagman" Lanterns increase light from end of globe.)

BULB SOCKETS

Machined from yellow brass bars. Coil springs press against base of bulbs; they cannot work loose. Contacts are capped coil springs; lamps can be focused over range of 3/16".

SWITCH

Bulb sockets are mounted in reflector on a slide. Lever moves slide to bring either bulb to center of reflector where it lights. Nothing to get out of order. It is impossible to light either Lamp by making contact between any two points on the exposed exterior surface of the lantern.

GUARD-STAND

Round rigid guards have welded steel ring with four curled-over braces, each individually riveted to battery case with two rivets. Designed so if lantern is swung against an obstruction the shock is cushioned and the lighted filament is less likely to break. Lantern No. 2142-6 has square base; swivels vertically.

LUCITE COVER FOR REFLECTOR

Protects light bulbs and reflector. Can be used on Nos. 2140, and 2142.

COVER FOR ONE LAMP BULB

Plastic cover in A.A.R. colors fits down over either lamp bulb and colors all light from that one bulb.

FRESNEL LENS, A.A.R. COLORS

Draws light into horizontal plane, reflector increases light from end. Fits on lantern No. 2140.

FRESNEL GLOBE, A.A.R. APPROVED

Approved both as to design and colors by A.A.R. Use with Flagman lantern No. 2172.

FLASHING LANTERN

Use Justrite Part No. 20,099. A .3 amp. 6 volt Flashing Lamp Bulb (No. 407) flashes on average of about 80 flashes per minute.

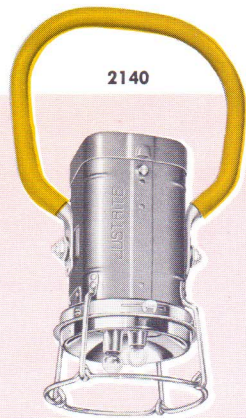

2140
WITH BAIL HANDLE
WITH 6" x 4" ARM SPACE

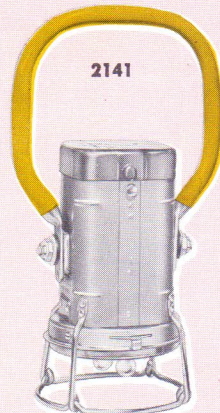

2141
WITH BAIL HANDLE
WITH 5" x 3" ARM SPACE

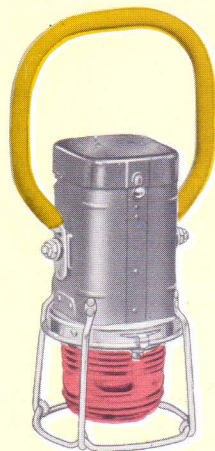

2172-2
WITH BAIL HANDLE
WITH 6" x 4" ARM SPACE

2173
HAS BAIL HANDLE
WITH 5" x 3" ARM SPACE

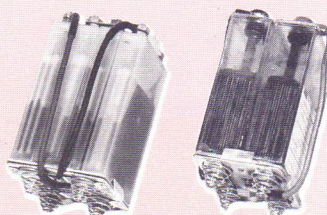

20,025

20,022

JUSTRITE TWIN-BULB LANTERNS

Flood Light and Beam at same time from either bulb. Change from one bulb to the other in one second. Each bulb held in place in a focusing socket by a heavy spring; **bulbs cannot work loose.** Bulbs are mounted on a slide, either bulb instantly lighted when moved by lever to the focal point of the reflector. Switch is mechanical; there is nothing to get out of order. Lantern is carried near center of gravity by insulated bail handle.

Model Number SPECIFICATIONS List Price Each Less Batteries

JUSTRITE NOS. 2140 and 2141 "TWIN-BULB" TRAINMAN'S LANTERNS COVER HINGED TO CASE.

Has completely brass circuit. Has Brass Reflector giving a 3 1/2" diam. beam. Has two focusing lamp sockets, one 1/4" higher than other. No lens, no globe. Has insulated bail handle. Furnished without light bulbs.

- 2140-1 With 6" x 4" bail handle..... \$5.80
- 2141-2 With 5" x 3" bail handle..... 5.80
- 2140-3 The Nos. 2140 and 2141 but with clear Lucite cover protecting reflector and lamp 6.40
- 2141-3
- 2140-5 The Nos. 2140 and 2141 but with Fresnel Lens in A.A.R. Colors. Specify Color..... 7.40
- 2141-5

COVER, A.A.R. COLORS, FOR ONE LAMP BULB ONLY Fits down over either lamp bulb to color all light from that one lamp only.

- 20,37* *2 Red, *3 Yellow, *4 Green, *5 Blue..... .20

"TWIN-BULB" CONDUCTOR'S LANTERN

The JUSTRITE "TWIN-BULB LIGHT-STICK" No. 2151 described on page 4 of catalog.

JUSTRITE NOS. 2172 and 2173 "TWIN-BULB" FLAGMAN'S LANTERNS COVER HINGED TO CASE.

Has completely brass circuit. Has insulated bail handle. Designed according to A.A.R. Sig. Sec. drg. No. 1346C to use Fresnel Globe, approved by A.A.R. Sig. Sec. (drg. No. 1609B). Globe held on reflector with three rigid clips and latch clip; easily removed without tools. Can be hung so light is seen from above.

- 2172-1 Furnished less Globe, less lamps. One in ship. ctn. Std. pkg. 12, wt. 24 lbs. \$6.95
- 2173-1
- 2172-* The Nos. 2172 and 2173 but with Fresnel Globe in A.A.R. Colors; specify color. *2 Red, *3 Yellow, *4 Green, *5 Blue. Furnished with two No. 27 Light Bulbs. One in ship. ctn. Std. pkg. 12, wt. 32 lbs.... 9.35
- 2173-*
- 2172-6 The Nos. 2172 and 2173 but with Clear White Fresnel Globe. Furnished with two No. 27 Light Bulbs. One in ship. ctn. Std. pkg. 12, wt. 32 lbs.... 9.00
- 2173-6

JUSTRITE GRADE CROSSING LANTERN

Light Shield to fit in guard of Flagman's Lantern No. 2172-2.

- 20,135 Light Shield only. Ship. wt. 1/2 lb..... 3.00

JUSTRITE STORAGE BATTERY UNITS RECHARGEABLE

Put in any Justrite No. 2140, 2141, 2172 or 2173 Lantern as you would the 6 volt dry battery. Lift out to charge, drop back in lantern when recharged. No connections to make.

- 20,022 Justrite 'Non-Spill' lead-acid, 4 volt, 6 amp. hr. 2 cell storage battery with contact plate. Rechargeable (100 to 150 cycles)..... \$15.00
- Justrite Nickel Cadmium Battery Nife C3.8M cells. Rechargeable (1000 cycles).
- 20,025 4 cell, 4.8 volt battery with contact plate.. 56.80

JUSTRITE STORAGE BATTERY CHARGERS for above batteries are available. Write for information.

CHARACTERISTICS OF VARIOUS COMBINATIONS OF MINIATURE LAMPS WITH SIZE 'D' CELLS AND 'LANTERN' BATTERIES

Model Nos. of JUSTRITE Electric Lights and Lanterns shown below are in the same space as Battery and Lamp Combinations you can use with them. Select Lamp by deciding how much light and battery life you want.

SELECT THE COMBINATION YOU WANT FROM THIS TABLE

Burning Life of Batteries.

When light or lantern is used as noted below the figures show the average actual burning time before the batteries drop to 60% of their output when new.

Battery Combinations and Correct Lamps (Light Bulbs) to use with them.

Model Nos. of JUSTRITE Electric Lights and Lanterns shown below are in the same space as Battery and Lamp Combinations you can use with them. Select Lamp by deciding how much light and battery life you want.	Arrangement of Batteries				Characteristics of Lamps (Light Bulbs)							Burning Life of Batteries.		
	Number used and Size	Connected in Series or in Parallel	Volts produced with batteries	Mfr's number for Lamp	Volts lamp is designed for	Amperes lamp is designed for	Average actual burning life	Spherical candle power at designed volts	Approximate maximum beam candle power at avg. volts	5 min. on 55 min. off in 8 hr. day	15 min. on 45 min. off in 8 hr. day	30 min. on 30 min. off in 8 hr. day	45 min. on 15 min. off in 8 hr. day	
1717, 1729, 1983	2 Size D	Series	3.0 V.	PR2	2.38 V.	.50 A.	15 hrs.	.75	1,500	3.5 hrs.	2.8 hrs.	2.0 hrs.	1.5 hrs.	
1911-4, 2106, 2305	3 Size D	Series	4.5 V.	PR7	3.70 V.	.30 A.	30 hrs.	.85	2,000	8.0 hrs.	7.0 hrs.	5.0 hrs.	3.5 hrs.	
	3 Size D	Series	4.5 V.	PR3	3.57 V.	.50 A.	15 "	1.40	4,000	3.5 "	2.8 "	2.0 "	1.5 "	
1704, 1904, 2105, 2106, 2151, 2301	3 Size D	Series	4.5 V.	13	3.70 V.	.30 A.	15 "	.90	2,000	8.0 "	7.0 "	5.0 "	3.5 "	
	3 Size D	Series	4.5 V.	365	3.69 V.	.50 A.	15 "	1.50	4,000	3.5 "	2.8 "	2.0 "	1.5 "	
1989	4 Size D	Series	6.0 V.	PR17	4.90 V.	.30 A.	30 hrs.	1.30	4,000	8.0 hrs.	7.0 hrs.	5.0 hrs.	3.5 hrs.	
	4 Size D	Series	6.0 V.	PR13	4.75 V.	.50 A.	15 "	2.30	7,000	3.5 "	2.8 "	2.0 "	1.5 "	
1708, -44, -88, 1903, 2107, -08, 2121, -31, -34, -40, -41, -42, -47, 2172, -73, 2209, -99	4 Size D	Series	6.0 V.	502	5.10 V.	.15 A.	100 "	.55	1,500	24.0 "	21.0 "	13.5 "	10.0 "	
	4 Size D	Series	6.0 V.	1403, 27	4.90 V.	.30 A.	30 "	1.30	4,000*	8.0 "	7.0 "	5.0 "	3.5 "	
2404 (Special)	5 Size D	Series	7.5 V.	PR12	5.95 V.	.50 A.	15 hrs.	3.00	10,000	3.5 hrs.	2.8 hrs.	2.0 hrs.	1.5 hrs.	
	5 Size D	Series	7.5 V.	31	6.15 V.	.30 A.	15 "	2.00	6,000	8.0 "	7.0 "	5.0 "	3.5 "	
1708, 1788, 1903, 2108, 2209	5 Size D	Series	7.5 V.	605	6.15 V.	.50 A.	15 "	3.30	10,000	3.5 "	2.8 "	2.0 "	1.5 "	
	8 Size D	Series	12.0 V.	993	9.83 V.	.30 A.	15 hrs.	3.40	8,000	8.0 hrs.	7.0 hrs.	5.0 hrs.	3.5 hrs.	
1911-2, 2209, 2299, 2411	8 Size D	Series	12.0 V.	965	9.84 V.	.50 A.	15 "	6.30	15,000	3.5 "	2.8 "	2.0 "	1.5 "	
	1 Lantern Battery consisting of 4 size F cells in Series		6.0 V.	PR17	4.90 V.	.30 A.	30 hrs.	1.30	4,000	22.0 hrs.	19.0 hrs.	15.0 hrs.	10.5 hrs.	
1708, -44, -88, 1903, 2107, -08, 2121, -31, -34, -40, -41, -42, -47, 2172, -73, 2209, -99	1 Lantern Battery consisting of 4 size F cells in Series		6.0 V.	PR13	4.75 V.	.50 A.	15 "	2.30	7,000	10.5 "	8.3 "	6.0 "	4.5 "	
	1 Lantern Battery consisting of 4 size F cells in Series		6.0 V.	502	5.10 V.	.15 A.	100 "	.55	1,500	65.0 "	57.0 "	48.0 "	34.0 "	
2404 (Special)	2 Lantern Batteries connected in Parallel		6.0 V.	1403, 27	4.90 V.	.30 A.	30 "	1.30	4,000*	22.0 "	19.0 "	15.0 "	10.5 "	
	2 Lantern Batteries connected in Parallel		6.0 V.	425	5.00 V.	.50 A.	15 "	2.50	7,000	10.5 "	8.3 "	6.0 "	4.5 "	
2401	2 Lantern Batteries connected in Parallel		6.0 V.	4546	4.70 V.	.50 A.	100 "	Sealed Beam	6,000	10.5 "	8.3 "	6.0 "	4.5 "	
2404 (Special)	2 Lantern Batteries connected in Parallel		6.0 V.	1651	5.00 V.	.60 A.	20 "	3.00	9,000	22.0 hrs.	19.0 hrs.	15.0 hrs.	10.5 hrs.	
2404 (Special)	2 Lantern Batteries connected in Parallel		6.0 V.	1553	4.75 V.	1.00 A.	50 "	5.50	18,000	10.5 "	8.3 "	6.0 "	4.5 "	
2404 (Special)	2 Lantern Batteries connected in Parallel		6.0 V.	{ Dbl. Fil. }	{ 4.75 V. }	{ 1.00 A. }	{ 50 "	{ 5.10	{ Flood	{ 10.5 "	{ 8.3 "	{ 6.0 "	{ 4.5 "	
2404 (Special)	2 Lantern Batteries connected in Parallel		6.0 V.	PR17	4.90 V.	.30 A.	10 hrs.	1.30	5,000	190.0 hrs.	105.0 hrs.	90.0 hrs.	70.0 hrs.	
2404 (Special)	2 Lantern Batteries connected in Parallel		6.0 V.	PR13	4.75 V.	.50 A.	5 "	2.30	9,000	58.0 "	25.0 "	43.0 "	30.0 "	
2401	2 Lantern Batteries connected in Parallel		6.0 V.	502	5.10 V.	.15 A.	50 "	.55	2,000	350.0 "	300.0 "	280.0 "	225.0 "	
	2 Lantern Batteries connected in Parallel		6.0 V.	1403, 27	4.90 V.	.30 A.	10 "	1.30	6,000*	120.0 "	105.0 "	90.0 "	70.0 "	
2404	2 Lantern Batteries connected in Parallel		6.0 V.	425	5.00 V.	.50 A.	5 "	2.50	9,000	58.0 "	52.0 "	43.0 "	30.0 "	
2401	2 Lantern Batteries connected in Parallel		6.0 V.	4546	4.70 V.	.50 A.	40 "	Sealed Beam	8,000	60.0 "	50.0 "	42.0 "	31.0 "	
2404	2 Lantern Batteries connected in Parallel		6.0 V.	4547	4.75 V.	1.25 A.	100 "	Sealed Beam	22,000	14.0 "	11.0 "	8.5 "	6.0 "	
2404	2 Lantern Batteries connected in Parallel		6.0 V.	1651	5.00 V.	.60 A.	10 "	3.00	10,000	42.0 "	37.0 "	31.0 "	22.0 "	
2404	2 Lantern Batteries connected in Parallel		6.0 V.	{ 1553 }	{ 4.75 V. }	{ 1.00 A. }	{ 50 "	{ 5.50	{ 20,000	{ 20.0 "	{ 16.0 "	{ 13.0 "	{ 9.0 "	
2404	2 Lantern Batteries connected in Parallel		6.0 V.	{ Dbl. Fil. }	{ 4.75 V. }	{ 1.00 A. }	{ 50 "	{ 5.10	{ Flood	{ 20.0 "	{ 16.0 "	{ 13.0 "	{ 9.0 "	
2140, -41, 2172, -73	4V. 6A. hrs. Stg. Bat.		4.0 V.	518	4.00 V.	.55 A.	250 hrs.	1.75	6,000	Total Burning Time over 10 hrs. on each full charge.				
2404	6V. 6A. hrs. Stg. Bat.		6.0 V.	157	5.80 V.	1.10 A.	50 "	6.00	20,000	Total Burning Time over 5 hrs. on each full charge.				
2404	6V. 6A. hrs. Stg. Bat.		6.0 V.	{ 1554 }	{ 5.90 V. }	{ .70 A. }	{ 100 "	{ 5.50	{ 22,000	Total Burning Time over 8 hrs. on each full charge.				
2404	6V. 6A. hrs. Stg. Bat.		6.0 V.	{ Dbl. Fil. }	{ 5.90 V. }	{ .70 A. }	{ 100 "	{ 5.10	{ Flood	Total Burning Time over 8 hrs. on each full charge.				

© 1959. JUSTRITE MANUFACTURING COMPANY, CHICAGO 14, ILL., U.S.A.

*FOR NO. 27 LAMP ONLY. NO. 1403 LAMP GIVES FLOOD LIGHT.

accessories and parts for all models

THE BRIGHTEST NAME IN LIGHTS

Model Number	DESCRIPTION	List Price Each
DRY BATTERIES: Please order in Standard Package		
20,011	"Energizer", electronic type, size "AA" (Std. Pkg. 72)....	\$0.22
20,012	"Energizer", electronic type, size "D" (Std. Pkg. 96)....	.82
20,014	Flashlight, Size "D" (Standard Package 96).....	.22
20,017	Lantern, 4 size "F" in series, 6 volt (Std. Pkg. 12).....	1.32
20,019	"Double Six" 6 volt steel clad.....	2.76
BATTERY CASE PARTS		
20,031	4 cell headlight case, 1 1/2" x 3" x 5 1/2", complete less cord	\$2.00
20,034	Bottom Contact Plate for 4 cell headlight case.....	.20
20,037	Plastic Pouch with loop for belt, for lantern battery.....	.80
20,040	Bottom with Contacts for Nos. 2301, 2305.....	.80
20,046	Cover, 3" x 3", with latch, for No. 1708, 1788.....	1.00
20,049	Cover, 3" x 3", with latch, for Safety Lantern No. 1744.....	.80
20,052	Cover, 3" x 3", with latch, for 1903, 2209.....	.30
20,058	Cover, 3" x 3", with latch for 2140, 2141, 2142, 2172.....	.15
20,061	Cover Latch (with rivet) for 3" x 3" battery case.....	.75
20,067	Bottom Assembly for No. 2140, less reflector, slide, lever..	1.00
20,070	Battery Case Sides with round guard for No. 2140.....	1.00
20,073	Seal, Wire to seal cover and lens to case.....Pkg. of 100	.10
20,076	Lever to operate Twin Bulb Slide.....	1.50
20,078	6 Volt Circuit Contact Plate with wire for Nos. 2401, 2404	2.00
20,079	6 V. - 12 V. Plate with wire for Nos. 2401, 2404.....	1.60
20,081	6 V. Contact Plate for Pendragon with socket on side.....	1.80
20,082	Case Cover (hinge, insulation) for Nos. 2401, 2404.....	\$.27
20,099	FLASHER LAMP BULB No. 407. .3 amp. Use 6 volt circuit...	
GUARDS AND STANDS (order fastener parts separately)		
20,111	Fixed Round Guard Stand for Nos. 2140, 2141.....	1.00
20,117	Fixed Round Guard Stand for Nos. 2172, 2173.....	1.00
20,120	Fixed Guard to protect reflector cover on No. 1744-8.....	1.00
20,123	Movable Stand for Safety Lantern No. 1744-8.....	1.00
20,125	Movable Stand for Nos. 2121, 2131 and 2142.....	.20
20,129	Rivets with washers, steel, to fasten guards.....per dozen	.40
20,132	Bolts, etc., steel, to fasten movable stand.....per pair	3.00
20,135	Light Shield only for Grade Crossing Lantern.....	
BAILS, HANDLES, LANYARDS, fastener parts separate		
20,140	Insulated Bails for Nos. 1744, 2140, 2141, 2142, 2172, 2173;	\$1.00
20,141	Space for arm about 6" wide, 4" high.....	1.00
20,147	Space for arm about 5" wide, 3" high.....	.40
20,148	Parts, steel, to fasten arm bail to lantern.....	.10
20,150	Small wire hand bail for Nos. 1788, 2108.....	1.00
20,153	Handle Replacement for Inspectors' Lanterns Nos. 2121, 2131	.40
20,156	Adj. Lanyard (with screw eye) to hang No. 2155.....	1.40
20,159	Adjustable Shoulder Strap, 50 in., with clips.....	
HEADLIGHT CORDS, BANDS, ETC.		
20,164	Cord, 50" Twinflex, 18 gauge with terminals.....	\$0.40
20,167	Cord, 50 in. "SJ", must use on Safety Headlights, 1704, 1708	.80
20,170	Headband for "Eagle Eye" Headlights Nos. 1911.....	.30
20,173	Headband for Nos. 1704, 1708, 1903, 1904.....	.45
20,179	Headpad for Nos. 1704, 1708, 1903, 1904.....	.10
20,182	Hook to hold Headlamp on Safety Helmet.....	.20
HOLDERS (MOUNTING BRACKETS)		
20,194	Wall Bracket to hold Nos. 1744, 2121, 2142.....	\$0.80
20,197	Revolving Holder, for Nos. 1744, 2121, 2142.....	1.00
20,200	Holder for No. 2302 with Suction Cups and Screws.....	.60
20,203	Wall Holder with screws for Nos. 1788, 2209, 2219, 2299..	1.00
20,204	Spring Arm replacement, for holder No. 20,203.....	.25
20,206	Holder No. 20,203 on stand to revolve.....	1.40
20,213	Bracket for Nos. 2401, 2404 mounted to turn.....	4.80
20,214	Bracket No. 20,213 designed for padlock.....	5.40
LAMPS — LIGHT BULBS		
Mfrs. No.		
20,224	243 Min. Sc. Base .27 amp. TL-3 bulb.....Pkg. of ten	\$1.70
20,233	13 Min. Sc. Base .30 amp. use 3 "D" cells....." " "	1.70
20,236	365 Min. Sc. Base .50 amp. use 3 "D" cells....." " "	1.70
20,239	PR17 Prefocused .30 amp. use 6 volt circuit.....Pkg. of ten	2.00
20,242	PR13 Prefocused .50 amp. use 6 volt circuit....." " "	2.00
20,245	502 Min. Sc. Base .15 amp. use 6 volt circuit....." " "	1.70
20,246	27 Min. Sc. Base .30 amp. use 6 volt circuit....." " "	1.70
20,250	1403 Tubular Lmp. S-2 Filament for Insp. Ltn.....	2.50
	Min. Sc. Base .30 amp., use 6 volt cir. Pkg. of ten	1.70
20,251	425 Min. Sc. Base 50 amp. use 6 volt circuit....." " "	2.70
20,099	407 FLASHING Min. Sc. Base, .30 a. 6 volt.....Pkg. of ten	2.50
20,254	4546 Sealed Beam, .5 amp. for 6 volts.....each	2.85
20,257	4547 Sealed Beam, 1.25 amp. for 6 volts.....each	4.00
20,260	518 Min. Sc. Base .55 A. use 4 V. Stg. B.....Pkg. of ten	8.00
20,261	157 Min. Sc. Base 1.10 A. use 6 V. Stg. B....." " "	12.50
20,263	1553 6 volt 1.0 amp. for dry batteries.....Pkg. of ten	12.50
20,264	1554 6 volt 0.7 amp. for storage batteries....." " "	2.00
20,271	PR12 Prefocused .50 amp. use 5 "D" cells....." " "	2.00
20,274	31 Min. Sc. Base .50 amp. use 5 "D" cells....." " "	1.70
20,277	605 Min. Sc. Base .50 amp. use 5 "D" cells....." " "	5.00
20,293	993 Min. Sc. Base .30 amp. use 12 volt circuit Pkg. of ten	2.50
20,295	965 Min. Sc. Base .50 amp. use 12 volt circuit....." " "	
LAMP SOCKETS — TWIN BULB SLIDES		
20,311	3/8" and 5/8" high sockets on bulb slide for Nos. 2140, 2141	\$1.00
20,314	"Kick-Out" sockets on bulb slide for Safety Lantern No. 1744	1.00
20,317	3/8" high sockets on twin bulb slide for Nos. 2142.....	1.00
20,320	3/8" high sockets with 3/4" extenders on slide for No. 2172	1.20
20,323	Wire to retain 4 1/2 volt lamp in safety socket.....	.10
20,326	Wire to retain 6 volt and No. 993 lamps in safety socket..	.15
20,329	Extender to raise lamp 3/4" in socket.....	.50
20,332	Extender to raise lamp 1/2" in socket.....	.40
LAMP SOCKETS, for Single Bulb Lights		
20,631	Adjustable Socket to hold and focus Double Filament D.C.	\$1.00
	Bayonet Base Lamp in 4 1/2" Reflector No. 20,628.....	0.20
20,635	Cup with Spring, to hold PR Lamp in 2 3/4" and 3" Ref.	.20
20,638	Cup with Socket, to hold Min. Sc. Base Lamp in 2 3/4" and	.20
	3" Reflector.....	2.60
20,644	4 3/8" Plastic Sealed Reflector Unit with a replaceable	
	Prefocused Lamp No. PR 13 as a light source.....	

Model Number	DESCRIPTION	List Price Each
RECHARGEABLE STORAGE BATTERIES		
20,022	Lead-Acid, non-spill, 2 cell, 4 volt, 6 amp. hrs. with con-	\$15.00
	tact plate for No. 2140, -41, -72, -73.....	
20,023	Lead-Acid, non-spill, 3 cell, 6 volt, 6 amp. hrs. with contact	22.50
	plate for Justrite Pendragon Lanterns.....	
20,026	Nickel-Cadmium for Pendragon Lanterns No. 2404.....	72.00
	5 cell, 6.0 volt, 3.8 amp. hrs. with contact plate.....	
LENS AND GLOBES FOR "TWIN-BULB" LANTERNS		
20,354	Fresnel glass cover, clear, for Nos. 2140, 2141, 2142.....	\$1.00
20,357	Fresnel glass cover, A.A.R. Red for Nos. 2140, 2141, 2142....	2.00
20,360	Lucite cover, 3 7/8" x 1 3/8" clear for Nos. 1744, 2140, -41, -42	.50
20,363	Lucite Cover, 3 7/8" x 1 3/8" Red for Nos. 1744, 2140, -41, -42	.80
20,372	Plastic Cover, A.A.R. Red, to color light from one bulb only	.20
20,373	Plastic Cover, A.A.R. Yellow, to color light one bulb only	.20
20,374	Plastic Cover, A.A.R. Green, to color light from one bulb only	.20
20,375	Plastic Cover, A.A.R. Blue, to color light from one bulb only	.20
20,382	Fresnel Globe, A.A.R. Red, for Lantern Nos. 2172, 2173.....	2.64
20,383	Fresnel Globe, A.A.R. Yellow, for Lantern Nos. 2172, 2173....	2.64
20,384	Fresnel Globe, A.A.R. Green, for Lantern Nos. 2172, 2173....	2.64
20,385	Fresnel Globe, A.A.R. Blue, for Lantern Nos. 2172, 2173....	2.64
20,386	Fresnel Globe, A.A.R. clear, for Lantern Nos. 2172, 2173....	2.00
20,391	Gasket for 3 7/8" Cover Glass or Lens.....	.05
20,394	Gasket for 2-13/16" Fresnel Globe on Nos. 2172, 2173.....	.08
20,397	Clips to hold 3 7/8" Cover Glass or Lens.....Set of 3	.20
LENS — For Lights with Single Lamp in Reflector		
20,421	2 1/2" glass, clear round flat.....	\$0.10
20,424	2 1/2" plastic, clear round flat.....	.20
20,427	2 1/2" honeycomb pattern, to spread beam.....	.25
20,430	2 1/2" thin plastic disc, red.....	.20
20,433	2 1/2" thin plastic disc, specify color.....	.20
20,441	2 3/4" glass, clear round flat.....	.10
20,447	2 3/4" honeycomb pattern to spread beam.....	.30
20,450	2 3/4" thin plastic disc, red.....	.12
20,453	2 3/4" thin plastic disc, specify color.....	.20
20,461	3" glass, clear round flat.....	.10
20,467	3" honeycomb pattern to spread beam.....	.25
20,470	3" thin plastic disc, red.....	.30
20,473	3" thin plastic disc, specify color.....	.40
20,481	3 3/4" glass, clear round, flat, for Crash Lantern No. 1740....	.20
20,487	4 1/2" glass, clear round flat.....	.40
20,490	4 1/2" plastic, clear round flat.....	1.00
20,493	4 1/2" honeycomb pattern to spread beam.....	.80
20,496	4 1/2" thin plastic disc.....	.40
20,501	Cylindrical, clear for Light House Type No. 2301.....	.50
20,503	Colored lining for cylindrical Light House type.....	.10
LENS RETAINING WIRES, FOR SINGLE BULB LIGHTS		
20,521	for 2 1/2" lens and reflector, regular type.....	\$0.05
20,524	for 2 1/2" lens and reflector, safety type.....	.05
20,530	for 3" lens and reflector.....	.10
LENS RINGS, FOR SINGLE BULB LIGHTS		
20,551	to hold 2 1/2" lens and reflector.....	\$0.25
20,554	2 1/2" lens ring with Rubber Collar for safety lights.....	.60
20,557	to hold 2 3/4" lens and reflector.....	.10
20,560	to hold 3" lens and reflector.....	.30
20,563	for 4 1/2" lens and reflector.....	.30
20,566	Rubber Lens Collar for 2 1/2" lens ring, will hold aux. lens..	.30
20,569	Rubber Lens Collar for 3" lens ring.....	.30
REFLECTORS — FOR "TWIN-BULB" LANTERNS		
20,581	3 1/2" for Nos. 2140, 2141, 2142.....	\$0.35
20,584	3 1/2" for No. 1744-7 Safety Lantern (non-magnetic).....	.50
20,587	3 1/4" for Nos. 2172 and 2173 Flagman Lanterns.....	.80
20,590	7" Auxiliary Reflector for Nos. 2142 and 2147.....	2.00
20,593	Screws to hold Reflector on Safety Lantern 1744-8.....Set of 3	.30
20,596	Screws to hold Reflector on Twin Bulb Lanterns.....Set of 3	.10
REFLECTORS — FOR SINGLE BULB LIGHTS		
20,611	2 1/2" for Safety Lights Nos. 1704, 1708, 1788.....	\$0.60
20,614	2 1/2" for Safety Flashlight No. 1717 only.....	.60
20,617	2 1/2" for Nos. 1903-6, 1904, 1983, 2105, 2121.....	.25
20,620	2 3/4" with Bushing for Nos. 2106, 2199, 2209, 2299, 2305....	.45
20,625	3" without Bushing for No. 2131.....	.65
20,626	3" with Bushing for Nos. 1903-2 and 1989.....	.70
20,628	4 1/2" with Bushing for adjustable lamp socket.....	2.40
20,630	Adjustable Socket to hold and focus Miniature Screw Base	
	Lamp in 4 1/2" Reflector No. 20,628.....	1.00
20,631	Adjustable Socket to hold and focus Double Filament D.C.	
	Bayonet Base Lamp in 4 1/2" Reflector No. 20,628.....	1.00
20,634	4 1/2" with Bushing for Cup to hold Miniature	
	Sc. Base Lamp or "PR" Lamp.....	2.20
20,635	Cup with spring to hold Pre-focused Lamp in reflector....	.20
20,638	Cup with Socket, to hold Min. Sc. Base Lamp in Reflector..	.20
20,644	4 3/8" Plastic Sealed Reflector Unit with a replaceable	
	Prefocused Lamp No. PR 13 as the light source.....	2.60
SAFETY 3 CELL FLASHLIGHT PARTS FOR Nos. 1717, 1729		
20,323	Wire to hold No. 365 lamp in Safety Socket.....	\$0.10
20,324	Lens Retaining Wire for No. 1717.....	.05
20,354	Lens Ring with rubber collar for No. 1717.....	.60
20,366	Rubber Collar only (will hold auxiliary lens).....	.30
20,614	2 1/2" Reflector with large hole for No. 1717 only.....	.60
20,661	Switch Button.....	.25
20,664	Switch Contact Spring.....	.10
20,667	Case Bottom Cover with spring contact.....	.60
20,670	Transparent Protector for lamp bulb on No. 1727.....	.10
20,673	Assembly to convert No. 1729 to No. 1717-8.....	1.80

Model Number	SPECIFICATIONS	List Price Each Less Batteries	DESCRIPTION
1704-8	<p>JUSTRITE SAFETY HEADLIGHT, 6 V.</p> <p>Approved by Underwriters' Laboratories, Inc. for use in Class 1, Group D, explosive atmospheres.</p> <p>Use 4 size D cells and Lamp No. 27 for general use; 425 for bright light; 502 for long battery life.</p> <p>Has 2½" headlamp on 18 gauge "SJ" approved 50" cord. Has honeycomb lens in rubber lens collar over clear lens.</p> <p>With one light bulb No. 27.</p>	\$9.50	<p>JUSTRITE SAFETY HEADLIGHT NO. 1704-8</p> <p>Use this light in place of a "hand" safety light when doing work that requires the use of both hands. The battery case which may be sealed is small and compact; fits easily in the pocket, or is worn on the belt. The headlamp is light in weight and does not interfere with head or arm action. Many jobs can be performed more quickly and easily with the light directly on the object being worked on and both hands free.</p>



1708-8	<p>JUSTRITE SAFETY HEADLIGHT SUPER POWER, 6 VOLT-12 VOLT</p> <p>Approved by Underwriters' Laboratories, Inc. for use in Class 1, Group D, explosive atmospheres.</p> <p>Use 8 size D cells in series with Lamp No. 993 to produce brilliant white light. Use one 6 volt lantern battery with Lamp No. 27 for general use; 425 for bright light; 502 for long battery life. Has 2½" headlamp on 18 gauge "SJ" approved 50" cord. Has honeycomb lens in rubber lens collar over clear lens.</p> <p>With one light bulb No. 993.</p>	\$10.00	<p>JUSTRITE SAFETY HEADLIGHT NO. 1708-8</p> <p>Use in place of a "hand" safety light when the work being done requires both hands and also requires more time and more light.</p> <p>12 Volt Power. With 8 flashlight batteries in series to produce 12 volts and light bulb No. 993 you get an intensely brilliant white light. You can locate and identify anything a greater distance.</p> <p>6 Volt Economy. Use one 6 volt lantern battery with light bulb No. 27 for general use; No. 425 for a brighter light; No. 502 for less light but maximum battery life.</p>
--------	--	---------	---



JUSTRITE SPECIAL PURPOSE LIGHTS

1730-7	<p>JUSTRITE AVIATORS' PENLIGHT</p> <p>Use two size AA penlight batteries. Plastic bulb holder has metal cover containing shield to color beam white or red as required. Battery holder, high impact strength, fungus resisting plastic with metal screw threads. Pocket clip switch cannot light when clipped in pocket.</p> <p>With one light bulb No. 222.</p>	
1730-9	<p>Flashlight, Type A-6B Penlight Spec. MIL-F-7326B (ASG) U. S. Air Force Stock No. 7700-332475. Less Batteries.</p> <p>One in cardboard box, 100 in ship. ctn.</p>	
1730-9	<p>The No. 1730-7 but with adjustable lanyard to hang penlight around neck. U. S. Navy type. Federal Stock No. GF6230-223-4547. Less batteries.</p> <p>One in box, 100 in ship. ctn.</p>	

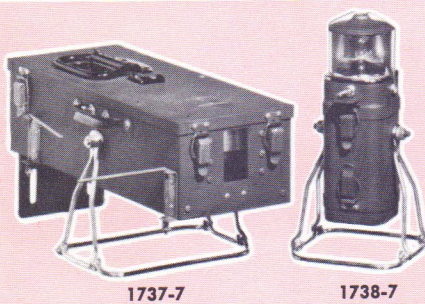

1740-8	<p>JUSTRITE HEAVY DUTY "FIRE TRUCK" LANTERN, 6 VOLT</p> <p>Approved by Underwriters' Laboratories, Inc. for use in Class 1, Group D Explosive Atmospheres. For one 6 volt lantern battery. Has 3½" reflector in headpiece protected by brass guard rigidly fixed on end of battery case. Battery case mounted to turn vertically on brass stand. Weatherproof. Large insulated bail handle and belt hook. With two light bulbs No. 425.</p>	
1740-7	<p>U. S. AIR FORCE "FIRE, RESCUE AND SEARCH" WEATHERPROOF ELECTRIC LANTERN, 6 VOLT</p> <p>U. S. Air Force, Stock No. 7700-526850. Justrite Lantern No. 1740-8 with "Quick Release" Mounting Bracket No. 20,209.</p>	
1740-7	<p>One in carton. Std. pkg. 8, wt. 45 lbs.</p>	

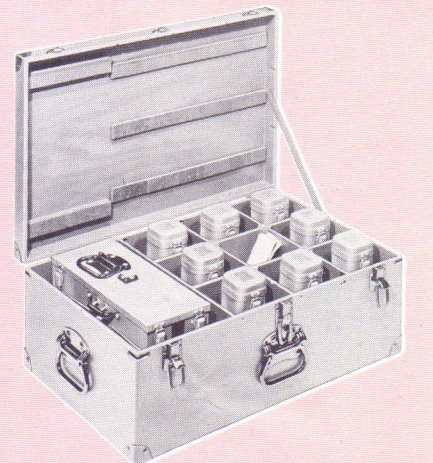
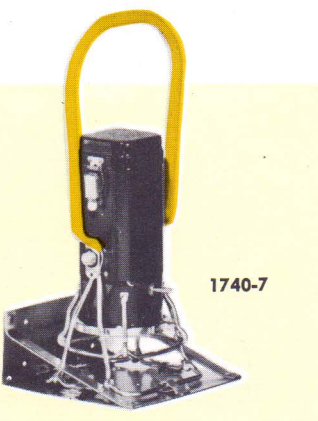

JUSTRITE HELICOPTER NIGHT VISUAL LANDING AID SYSTEM

Approach Light, 12 volt dry battery operated, projects rectangular pattern of Yellow, Green and Red light upward at desired angle. Two lamp bulbs and two circuits.

Marker Light operates on 6 volts and gives light in all or any direction in a horizontal plane which may be tilted to any angle. Amber, Blue, Green and Red color filters supply colored light.

1739-7 Set consists of one Approach Light and eight Marker Lights packed in strong wooden box, size 27 in. x 17 in. x 10 in.; weight 52 lbs.

1725-7	<p>JUSTRITE BEACH LANDING LIGHT</p> <p>Use one 6 volt lantern battery. A modified No. 2108; made of brass. Weatherproof. Has long "tubular" hood to direct light, one each red, green, blue and yellow disc to color light, and .30 Amp. flasher to blink light. Has clamp so it may be rigidly fastened to tubular support to direct light at a given spot. Olive drab color. U. S. Marine Corps Stock no. 17-F-13550-10.</p> <p>With 3 No. 27 Lamps and 2 Flashers.</p>	
1725-7	<p>One in ship ctn. Std. pkg. 14, wt. 56 lbs.</p>	



JUSTRITE OILY WASTE CANS

Prevents fires due to solvent and oily waste, rags and other spontaneous combustible material. Designed for maximum circulation of air under bottom and around sides. Can is cooled even if placed in corner. Cover opens to an angle of 60 degrees and falls back when released. Made of No. 22 and 24 gauge steel, heavily coated with lead or zinc. Legs 4" high, handle 3".

- Approved and Individually Labeled and Numbered, Underwriters' Laboratories, Inc.
- Approved, Associated Factory Mutual Fire Ins. Cos.
- Complies with all major requirements of U. S. Govt. Fed. Spec. No. RR-C-114-b.

WITH FOOT LEVER TO LIFT COVER

Capacity	Body Size		No. in Carton	Ship Wt.	Model No.	List Pr. Each
	Diam.	Height				
6 Gal.	11¾"	13"	1	11 lbs.	9-100.....	\$11.40
10 Gal.	13½"	15"	1	14 "	9-300.....	12.40
14 Gal.	15½"	17"	1	17 "	9-500.....	15.00
25 Gal.	19"	20½"	1	25 "	9-700.....	28.00

WITHOUT FOOT LEVER; LIFT COVER BY HAND

Capacity	Body Size		No. in Carton	Ship Wt.	Model No.	List Pr. Each
	Diam.	Height				
6 Gal.	11¾"	13"	1	9 lbs.	9-110.....	\$10.40
10 Gal.	13½"	15"	1	12 "	9-310.....	11.40
25 Gal.	19"	20½"	1	23 "	9-710.....	26.00
40 Gal.	22"	25"	1	36 "	9-910.....	36.00

Note: 25 and 40 Gal. sizes, not shipped in carton.

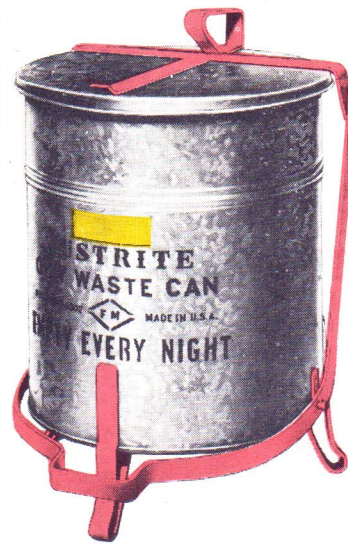

WITH FOOT LEVER

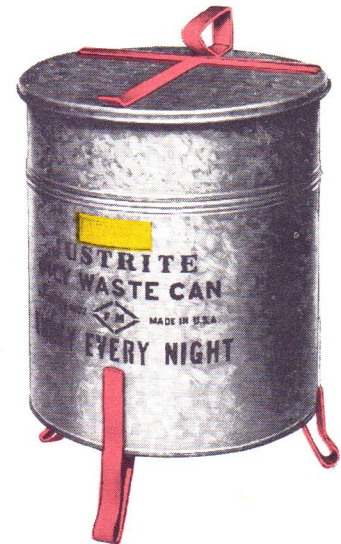

WITHOUT FOOT LEVER

JUSTRITE IMPROVED PLUNGER CANS

Use in all cleaning and sponging applications for safely dispensing flammable liquids. Interior parts brass; bodies steel, lead coated. Plunger may be adjusted to control amount of liquid used. Large cover allows easy access to inside of can to remove dirt and grit. For safety actual capacity is about 20% greater than rated capacity.

- Approved, Associated Factory Mutual Fire Ins. Cos.

Capacity	Body Size		No. in Carton	Ship Wt.	Model No.	List Pr. Each
	Diam.	Height				
1 Quart	7¼"	4½"	1	2½ lbs.	10108.....	\$ 7.00
½ Gal.	7¼"	6½"	1	3 "	10208.....	7.60
1 Gal.	7¼"	9¼"	1	3½ "	10308.....	9.60

Replacement Parts for Plunger Cans

Part No.	Description	List Pr. Each
11150	5" Pan with 3½" screen (for all sizes).....	\$1.30
11151	Adjusting Nut (for all sizes).....	.15
11152	Plunger Spring for No. 10108.....	.10
11157	Plunger Spring for No. 10208 and 10308.....	.15

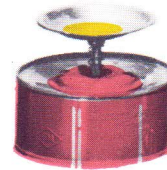

QUART

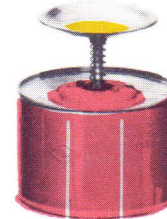

HALF GALLON

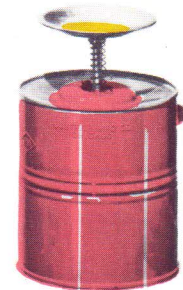

GALLON

JUSTRITE LABORATORY CAN

- Approved, Associated Factory Mutual Fire Ins. Cos.

For economy, convenience, safety. Use whenever flammable liquid is stored where it is being used. Justrite 5 Gal. Safety Can, with self closing, Factory Mutual Approved, Safety Faucet (Imperial No. 270-G, Cast Bronze) in a ¾" bushing on side above bottom seam. With Flash Arresting Screen in fill opening of can.

Specifications	Material	Number	List Pr. Ea.
5 Gal. Laboratory Can with Flash Arresting Screen with Approved Faucet	Terne Plate	10809	\$ 25.00
	Hot Tin Dipped	10849	34.00
	316 Stainless Steel	10869	48.00
Safety Screen, replacement for fill opening of can	Cadmium Plated	11099	1.00
	316 Stainless Steel	11097	3.75
Self Closing Safety Faucet Factory Mutuals Approved	Cast Bronze Imperial No. 270-G	11270	9.00



LABORATORY CAN



BENCH CAN

10,370



DRIP CAN

JUSTRITE BENCH and DRIP CANS

- Approved, Associated Factory Mutual Fire Ins. Cos.

JUSTRITE BENCH CAN for washing and cleaning parts used in assembly operations. Parts to be cleaned are placed in parts basket on top of perforated dasher, or directly on the perforated dasher itself.

JUSTRITE DRIP CAN to place under faucet of barrel or drum to prevent drip from faucet reaching floor.

	Capacity		Body Size		No. in Carton	Ship. Weight	Model No.	List Pr. Each
	Min.	Max.	Diam.	Height				
BENCH CAN	½ Gal.	1 Gal.	9¾"	4½"	1	4¾ lbs.	10370	\$12.00
DRIP CAN		1 "	9¾"	4½"	1	4½ "	10376	7.60

WHY YOU SHOULD USE A SAFETY CAN

The only cans safe to use for flammable or highly volatile liquids are those which are labeled by, or have stamped on them the insignia of, the organization which tested and approved them. Cans designed for safety will not tip over if placed on an incline of thirty degrees; if placed on their side they will not leak more than four drops a minute; if thrown in a fire they will not explode, the liquid will be safely contained until completely vaporized.

There is a difference between many so-called safety cans, and cans designed for safety that have been tested and approved by an authorized organization. Get a genuine safety can and avoid a possible catastrophe. Type I is the conventional design with short valved spout used to both pour and fill. Type II pours through a flexible tubular nozzle attached to a valved spout and is known as a "filling can".

"Remember five gallons of gasoline explode with as much force as 415 lbs. of dynamite"
— U.S. Army Engineers.



PINT SPOUT 1" I.D. QUART SPOUT 1 1/8" I.D. HALF GALLON SPOUT 1 1/2" I.D. GALLON SPOUT 1 3/4" I.D.



TWO GALLON SPOUTS 1 3/4" INSIDE DIAMETER THREE GALLON SPOUTS 1 3/4" INSIDE DIAMETER FIVE GALLON SPOUTS 1 3/4" INSIDE DIAMETER

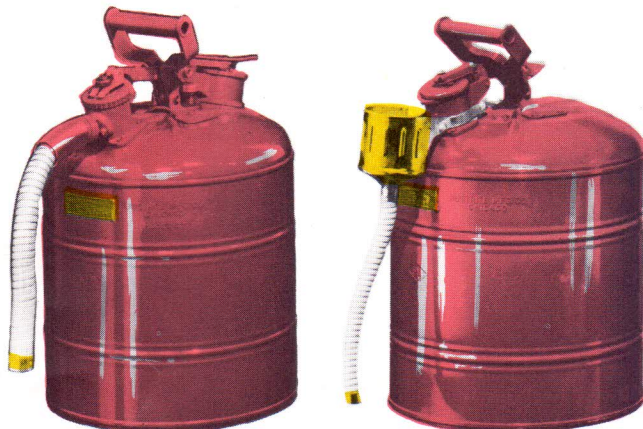

TYPE 2 JUSTRITE FIVE GALLON SAFETY FILLING CAN

POURING ATTACHMENT NO. 11088 ON TYPE I JUSTRITE SAFETY CAN

Built-in Connections for Flexible Hose Nozzle. Separate Filler Opening.

May be quickly attached or removed. Avoid spilling in places difficult to reach.

WHY YOU SHOULD USE A JUSTRITE SAFETY CAN

Bodies are ribbed for extra strength. Made of copper bearing steel heavily coated (15 lb.) with lead. The Justrite method of manufacture does not stretch or burn the material and insures an "all over" lead coating of maximum uniform thickness, both outside and inside; gives longer life. Even if Can is wrapped in flames, seams remain tight until fire evaporates contents. Self aligning cover and cover spring are mounted on the heavy cast spout. Even if Can is abused and handle broken, cover remains tight. Pouring lip on spout permits pouring small stream and serves as "hook" to support Can and ground any static charge before pouring. Two, three and five gallon Cans have a heavy reinforcing ring around bottom and a swing handle. Pick up, carry with one hand, pour without first placing on ground to get a different grip. Saves time; reduces fatigue.

JUSTRITE SAFETY CANS, TYPES I and II

- Approved and Individually Labeled and Numbered Underwriters' Laboratories, Inc. Flash arresting screens or baffles are not required.
- Approved, Associated Factory Mutual Fire Ins. Cos. Cans larger than 1 gal. used for solvents and thinners, should have flash arresting screen.
- Approved, New York City Fire Dept., Approval No. 92. Flash arresting screens or baffles are required.
- Meets U. S. Fed. Spec. RR-S-30 (RR-C-92). When equipped with screen.

JUSTRITE FLASH ARRESTING SCREENS dissipate heat quickly and do not retard pouring. They are held in the one piece cast spout with a heavy locking ring and cannot fall out or be shaken out. They can be removed for cleaning as required by Underwriter's Laboratories, Inc.

JUSTRITE SAFETY CANS, "TYPE I," conventional design with short valved spout used to pour and fill

15 LB. TERNE PLATE			No. in Carton	Ship. Wt.	Without Screens		With Screens	
Capacity	Diam.	Height			No.	List Pr. Each.	No.	List Pr. Each.
1 Pint	4 3/8"	6 3/4"	6	12 lbs.	10000...	\$5.80	10001...	\$6.80
1 Quart	4 3/8"	8 1/4"	6	14 "	10100...	6.00	10101...	7.00
1/2 Gal.	7 1/4"	8 3/8"	6	19 "	10200...	6.80	10201...	7.80
1 Gal.	7 1/4"	11 1/2"	6	24 "	10300...	7.20	10301...	8.20
2 Gal. *	9 3/8"	12 5/8"	1	7 "	10500...	9.00	10501...	10.00
3 Gal.	9 3/8"	16 1/8"	1	8 "	10700...	9.40	10701...	10.40
5 Gal. *	11 1/2"	17"	1	9 "	10800...	10.40	10801...	11.40

IMPERIAL MEASURE CANS FOR USE IN CANADA			No. in Carton	Ship. Wt.	Without Screens		With Screens	
Capacity	Diam.	Height			No.	List Pr. Each.	No.	List Pr. Each.
1 Imp. Gal. 7 1/4"	12 5/8"	17"	6	27 "	10400...	7.60	10401...	8.60
5 Imp. Gal. 11 1/2"	17"	19"	1	10 "	10900...	11.20	10901...	12.20

*This Can tested and Approved by Bell Telephone Laboratories. Justrite Safety Cans are Approved for Bell System Use. JUSTRITE SAFETY CANS ARE AVAILABLE HOT TIN DIPPED. To order add "HT" after the MODEL NUMBERS in the tables above.

JUSTRITE SAFETY CANS, STAINLESS STEEL TYPE I

NO. 316 STAINLESS (UNPAINTED) BEST TO STORE CORROSIVE LIQUIDS.

1 Quart	4 3/8"	8 1/4"	6	14 lbs.	10162...	\$22.00	10163...	\$25.20
1 Gal.	7 1/4"	11 1/2"	6	24 "	10362...	26.00	10363...	29.75
5 Gal.	11 1/2"	17"	1	9 "	10862...	36.00	10863...	39.75

JUSTRITE SAFETY FILLING CANS, "TYPE II," pours thru flexible tubular nozzle attached to valved spout

With "Built In" Connection for Flexible Hose. With Flexible Hose 1 in. diam., 12 in. long.

3 Gal.	11 1/2"	13 1/2"	1	10 lbs.	10721...	\$21.00		
5 Gal.	11 1/2"	17"	1	12 "	10820...	\$20.00	10821...	22.00

POURING ATTACHMENT FOR "TYPE I" CANS

QUICKLY ATTACHED OR REMOVED
Use on Justrite Type I Cans, 1/2 Gal. and larger.
3" Brass Cup with 100 mesh strainer.
With flexible hose 3/4" x 9 1/2" long. No. 11088.....\$3.80

SAFETY SCREENS, WASHERS, SPRINGS, PARTS

TYPE I CANS	For Pt. and Qt. Sizes		For 1/2 Gal. and larger	
	No.	List Pr. Each	No.	List Pr. Each
Screen, 316 Stainless	11096.....	\$3.20	11097.....	\$3.75
" Steel Cad. Plated	11098.....	1.00	11099.....	1.00
Cover Assembly, Complete	11021.....	.65	11001.....	1.00
Treated Leather Washer	11022.....	.15	11002.....	.20
Spout Cover Spring	11024.....	.20	11004.....	.20
Lever to open spout	11027.....	.30	11007. 1/2 & 1 G	.30
Handle with Spring, for 2, 3 and 5 gal. cans			11011.....	.70
TYPE II CANS				
Set of two Screens for Safety Filling Can			11072.....	2.00
Flexible Hose Replacement for Safety Filling Can			11077.....	2.40
Air Vent for Safety Filling Can			11035.....	1.00

JUSTRITE IMPROVED CARBIDE HEAD LAMP WITH BRILLIANT BURNER TIP

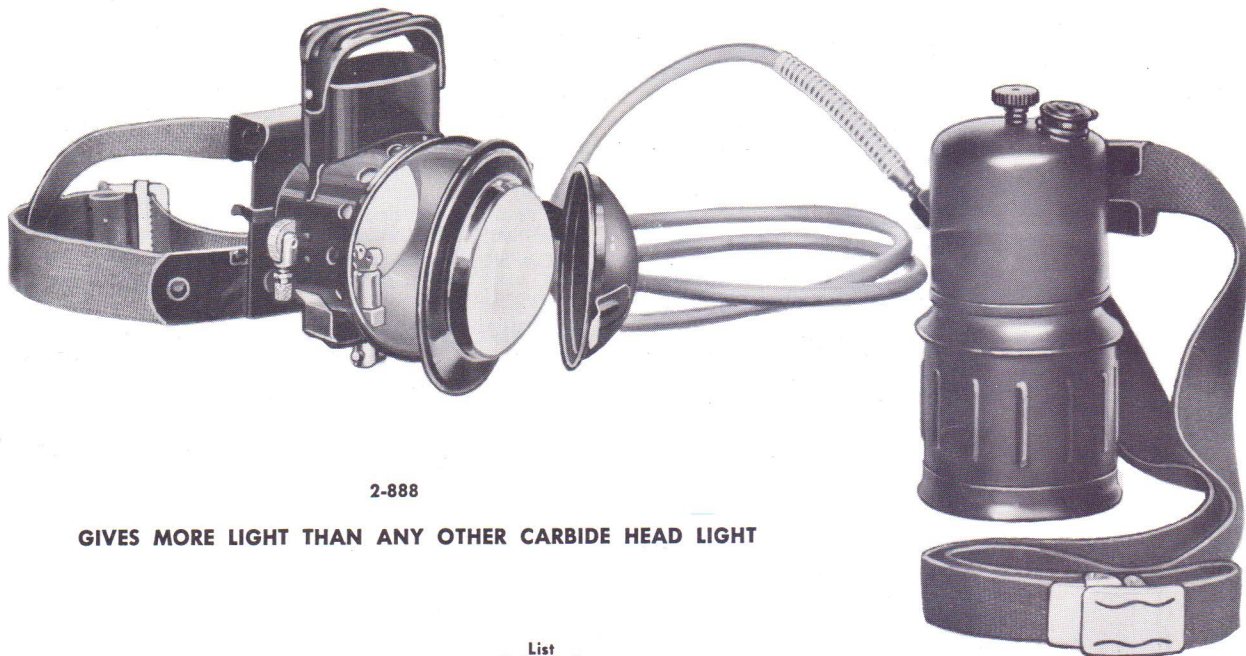

2-888

GIVES MORE LIGHT THAN ANY OTHER CARBIDE HEAD LIGHT

Number	Description	List Price Each
--------	-------------	-----------------

2-888 JUSTRITE CARBIDE HEAD LAMP

Enclosed flame lamp. Housing has reflector and two lenses, one a bull's eye, and darkening door for use when total darkness is desired. Burner with brilliant new tip No. 5-867 is removable; can be used as a gas jet for interior lighting. Furnished complete with headstrap, to hold lamp on head, and canvas belt to hold generator at waist.

List Price Each..... \$12.80

Domestic packing;
1 in carton, shipping weight about 2½ lbs.
Export packing extra; charged for at cost.
100 in wirebound box, weight about 295 lbs.

THE FINEST CARBIDE HEAD LAMP MADE

Designed for rugged use in forests, jungles, swamps and used where unfailing light is absolutely necessary for protection and to accomplish your purpose. Burns about 8 hours on 8 ounces of Miners Lamp Carbide (½" lumps) and water. Equipped with self lighter attachment. Generator is steel, lacquered black, and worn on belt furnished with lamp. Water feed is automatic and valve stem can be taken out and cleaned and lamp continues to burn. Generator is attached to head lamp by means of high quality, long wearing rubber hose, covered at ends with coiled springs to prevent kinking. Brilliant new burner tip gives a more powerful light beam.

REPLACEMENT AND REPAIR PARTS

Number	Description	List Price Each
5-158	Ferrule for 5-159 Valve Stem	.10
5-159	Valve Stem	.40
5-172	Flints, 1 in capsule, per capsule	.04
5-177	Lighter Complete	.25
5-520	Felt Packing	.05
5-530	Felt Holder for 5-520 Felt	.15
5-561	Rubber Gasket	.06
5-801	Generator, Complete	5.60
5-802	Bottom for Generator	1.50
5-803	Pins to hold rubber hose to cap. Pair	.10
5-805	3" Lens, convex	.12

Number	Description	List Price Each
5-807	Headstrap	.86
5-808	Rubber Hose	.62
5-809	Belt to hold Generator	.52
5-810	Bulls Eye Lens with frame	.70
5-811	Darkening Door	.40
5-812	2½" Bulls Eye Lens	.35
5-816	Lens Retaining Wire, 3"	.16
5-867	Brilliant Fish Tail Burner Tip	.70
5-881	Head Lamp	4.50
5-883	Reflector	.42
5-884	Tube with Tip	1.50

JUSTRITE ACCESSORIES AND CAPS

Number	Description	List Price Each
5-012	Carbide in 2 lb. can, per can	\$1.00
5-015	Empty Wood Tube to hold reamers	.08
5-037	Tip Cleaner with sliding covers	.32
5-075	Match Box — Waterproof	.40
5-244	Men's Canvas Caps, adjustable	1.50
5-245	Reamers in tubes of 12 per tube	.78
5-248	Reamers in bulk	.06
5-650	Clip to hold 800 type lamp on cap	.25

FLINTS AND LIGHTER PARTS

Number	Description	List Price Each
5-172	Flints, 1 in capsule, per capsule	.04
5-173	Spring to push flint	.02
5-174	Screw Cap to hold spring	.04
5-175	Sparker Wheel	.06
5-176	Fork to hold wheel with nut	.12
5-177	Lighter Complete	.25
5-182	Hex Nut to fasten lighter	.02

for bright, white light at low cost

THE BRIGHTEST NAME IN LIGHTS

JUSTRITE CARBIDE LAMPS

are safe, reliable, and produce a bright white light at a low cost. Easy to operate and maintain, they are used out of doors where light is required for several hours at a time and cost of operation is an important factor.

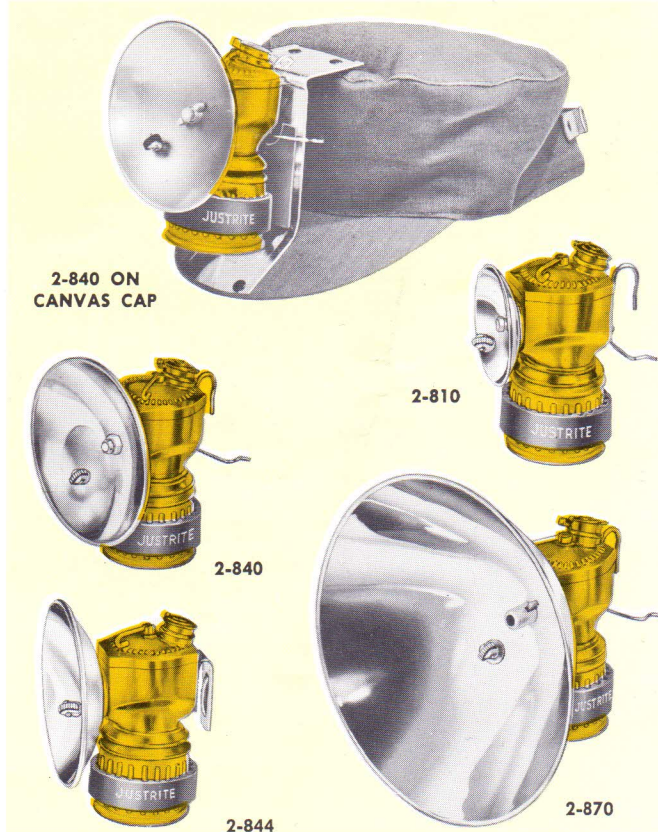

JUSTRITE FOUR HOUR CARBIDE CAP LAMPS

Streamlined, made of brass, 4" high, 2" diam. at bottom; highly polished and lacquered. Reflectors have self-lighter attachments and are steel highly polished and chrome plated; 7 inch reflectors are brass, nickel plated. Burn about 4 hours using 3 1/4 ounces of Miners Lamp Carbide (1/2" lumps) and water. Water feed may be regulated to get size of flame desired. Air cooled rubber grip on bottom makes lamp easier to handle.

Model Number	Reflector Diam.	Packed one in Cardboard Box				List Price Each
		Domestic Packing in shipping carton		*Export Packing in wire bound case		
		Quantity	Weight	Quantity	Weight	
WITH ROUND HOOK TO ATTACH LAMP TO CAP						
2-810	2 1/2"	12	7 lbs.	500	310 lbs.	\$3.40
2-840	4"	12	8 lbs.	342	270 lbs.	3.70
2-870	7"	12	14 lbs.	144	225 lbs.	4.95
*Export packing extra; charged for at cost						
WITH FLAT HOOK, 3/4" WIDE, TO ATTACH LAMP TO "HARD" SAFETY HAT						
2-844	4"	12	9 lbs.	345	298 lbs.	3.70

REPLACEMENT PARTS Additional Accessories and Parts on Page 14

Number	Description	List Price Each
5-128	"Jewel" Burner Tip	.10
5-136	7" Reflector with Lighter	2.40
5-172	Flints, 1 in capsule, per capsule	.04
5-177	Lighter Complete	.25
5-180	Flame Protector	.10
5-185	Water Door	.30
5-197	Wing Nut to hold Reflector	.10
5-600	Rubber Gasket	.04
5-602	2 1/2" Reflector with lighter	.90
5-604	4" Reflector with lighter	1.00
5-620	Felt Packing	.03
5-630	Felt Plate for No. 5-620 Felt	.03
5-640	Felt Holder for No. 5-620 Felt	.10
5-650	Clip to hold lamp on cap	.25
5-662	Rubber Grip, Air Cooled	.12
5-669	Bottom with Rubber Grip	.80
5-690	Cap Spring (on lamp)	.04
5-698	Reflector Brace	.05
5-807	Headstrap	.86

JUSTRITE EIGHT HOUR CARBIDE HAND LAMPS

Automatic Feed — Equipped with Flame Protector. Justrite automatic water feed generators are the only generators in which the valve stem can be taken out and cleaned and the light continues to burn. Made of brass, highly polished, except No. 2-500 which is steel, tinned. Brass lamps are reinforced at bottom with steel, cadmium plated. Reflectors have self-lighter attachments, and are highly polished and chrome plated; 4" diam. except on No. 2-571 which is 7" diam., nickel plated. Burn about 8 hours on 8 ounces of Miners Lamp Carbide (1/2" lumps); flame bright and steady, protected from wind by flame protector.

Model Number	Type of Handle	Packed one in Cardboard Box				List Price Each
		Domestic Packing in shipping carton		*Export Packing in wire bound case		
		Quantity	Weight	Quantity	Weight	
2-500†	Bail & Hook	24	44 lbs.	100	185 lbs.	\$6.00
2-501	Bail & Hook	24	44 lbs.	100	185 lbs.	6.40
2-561	Back Handles	24	36 lbs.	100	170 lbs.	6.95
2-571	Back Handles	12	26 lbs.	144	340 lbs.	7.45
†Steel		*Export packing extra; charged for at cost				

REPLACEMENT PARTS Additional Accessories and Parts on Page 14

Number	Description	List Price Each
5-128	"Jewel" Burner Tip	.10
5-136	7" Reflector, with lighter	2.40
5-158	Ferrule or No. 5-159 Stem	.10
5-159	Valve Stem	.40
5-172	Flints, 1 in capsule, per capsule	.04
5-177	Lighter Complete	.25
5-180	Flame Protector	.10
5-197	Wing Nut to hold Reflector	.10
5-505	4" Reflector with Lighter	1.10
5-510	Bottom, steel	1.30
5-511	Bottom, brass	1.80
5-520	Felt Packing	.05
5-530	Felt Holder for No. 5-520 Felt	.15
5-554	Reflector Brace	.05
5-561	Rubber Gasket	.06

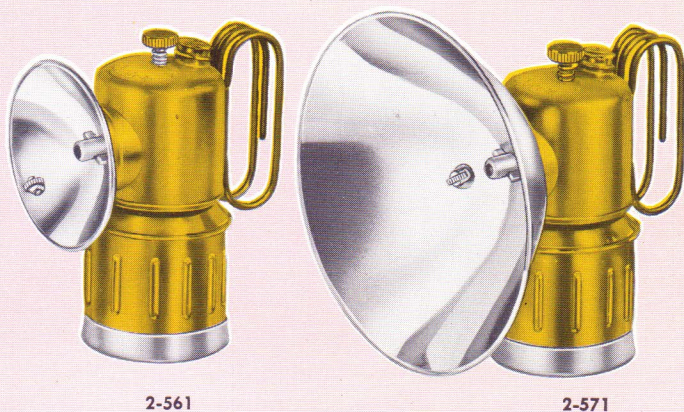
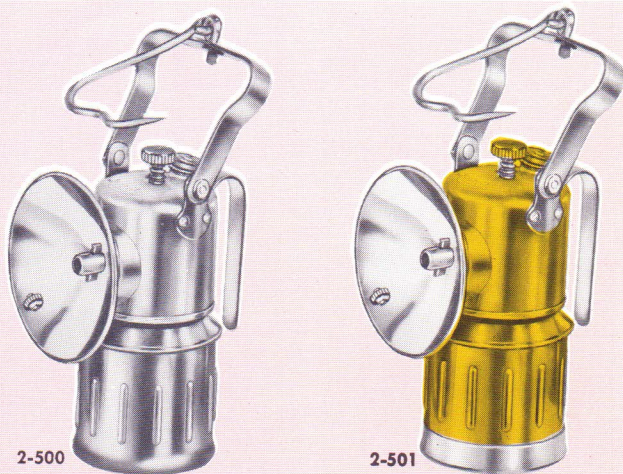



Phone: Diversey 8-2114
Cable: "JUSTRITE"

JUSTRITE MANUFACTURING COMPANY
2061 NORTH SOUTHPORT AVENUE
CHICAGO 14, ILLINOIS

Branch Office:
NEW YORK CITY

JUSTRITE MANUFACTURING COMPANY

PRICE LIST NO. 590-C — FOR USE WITH CATALOG NO. 589

Effective November 16, 1959

Model No. List Pr. Each

PAGE 2

Pendragon Lanterns, Etc.

2401-4	\$22.95
2404-3	23.95
20159 Strap	1.40
2401-5	25.95
2404-5	25.95
20213 Bracket	4.80
20214 Bracket	5.40
2404-9	P.O.R.
20023 Battery	P.O.R.
2411-1	7.95
2411-6	8.95

PAGE 3

General Use Lights

2209-1	\$ 5.95
2434-3	P.O.R.
20019 Battery	2.76
2299-0	4.95
2305-1	4.75
2305-4	5.25
2301-3	4.25

PAGE 4

Light-Stick Lights

2106-4	P.O.R.
2105-4	5.95
2105-6	5.95
2151-1	P.O.R.
2155-1	2.25
2155-2	2.70
20011 Battery	.22
20224 Bulb	.17
20156 Lanyard	.40
2142-6	7.45
20590 Reflector	2.00
2037* Bulb Covers	.20

PAGE 5

Electric Headlights

1903-6	\$ 5.95
1904-4	4.95
1903-2	4.30
1904-2	2.95
1911-2	3.50
1911-4	5.50
1983-1	6.95
1989-1	8.95

PAGE 6

Inspectors Lights

2434-4	P.O.R.
2434-6	P.O.R.
2434-3	P.O.R.
20019 Battery	2.76
20159 Strap	1.40
2131-1	7.50
2121-1	8.95
2219-2	5.95
2107-6	4.95
5-809 Belt	.52
1903-5	6.25

Model No. List Pr. Each

PAGE 7

"Twin-Bulb" Lanterns

2140-1	\$ 5.80
2141-2	5.80
2140-3	6.40
2140-5	7.95
2037* Bulb Covers	.20
2172-1	7.35
2172*	9.95
2172-6	9.00
20135 Shield	3.00
20022 Battery	P.O.R.
20025 Battery	P.O.R.

PAGE 9

See Complete List of Parts
and Accessories on Back (over).

PAGE 10

Safety Headlights

1704-8	\$ 9.95
20182 Hook	.20
1708-8	Discontinued

Special Purpose Lights

Please write for complete
specifications and availability.

PAGE 11

Safety Hand Lights

1717-8	\$ 5.75
20427 Honeycomb Lens	.25
1729-8—15"	17.95
1729-8—30"	19.95
1729-8—Spl. Length	P.O.R.
1744-8	8.95
1744-7	18.00
1746-8	10.00
1788-8	10.95

PAGE 12

Oily Waste Cans

9-100	\$11.70
9-300	12.50
9-500	15.00
9-700	28.00
9-110	10.40
9-310	11.40
9-710	26.00
9-910	36.00

Plunger Cans

10108	\$ 7.50
10208	7.90
10308	9.80
11150 Pan	1.30
11151 Nut	.15
11152 Spring	.10
11157 Spring	.15

Laboratory Can

10809	\$25.00
10849	34.00
10869	52.00
11099 Screen	1.20
11097 Screen	3.75
11270 Faucet	9.00

Bench and Drip Cans

10370	\$12.00
10376	9.00

Model No. List Pr. Each

PAGE 13

Safety Cans—Type I

10000	\$ 6.20
10001	7.20
10100	6.40
10101	7.40
10200	7.00
10201	8.20
10300	7.20
10301	8.40
10500	9.40
10501	10.60
10700	9.80
10701	11.00
10800	10.40
10801	11.60

Imperial Measure

10400	7.80
10401	9.00
10900	11.80
10901	13.00

Stainless Steel

10162	23.00
10163	26.20
10362	27.00
10363	30.75
10862	39.00
10863	42.75

Type II—Filling Cans

10721	22.00
10820	21.00
10821	23.00

Pouring Attachment

11088	3.80
-------	------

Screens, Washers, Parts

11096	3.20
11097	3.75
11098	1.00
11099	1.20
11021	.65
11001	1.00
11022	.15
11002	.20
11024	.20
11004	.20
11027	.30
11007	.30
11011	.70
11072	2.00
11077	2.40
11035	1.00

PAGES 14 & 15

Carbide Head Lamp

2-888	\$12.80
-------	---------

Carbide Cap Lamps

2-810	3.40
2-840	3.70
2-870	4.95
2-844	3.70

Carbide Hand Lamps

2-500	6.00
2-501	6.40
2-561	6.95
2-571	7.45

NOTE: Parts and Accessories for Electric Lights and Lanterns and for Carbide Lamps are listed, in Numerical Order, on other side.
For Items marked P.O.R. (Price On Request) please write for information.

JUSTRITE MANUFACTURING COMPANY

PRICE LIST NO. 590-C — FOR USE WITH CATALOG NO. 589

Effective November 16, 1959

Part No. List Pr. Each

PAGES 14 & 15

**Parts and Accessories
For Carbide Lamps**

5-012	\$ 1.15
5-015	.08
5-037	.32
5-075	.40
5-128	.10
5-136	2.40
5-158	.10
5-159	.40
5-172	.04
5-173	.02
5-174	.04
5-175	.06
5-176	.12
5-177	.25
5-180	.10
5-182	.02
5-185	.30
5-197	.10
5-244	1.50
5-245	.80
5-248	.07
5-505	1.10
5-510	1.30
5-511	1.80
5-520	.05
5-530	.15
5-554	.05
5-561	.06
5-600	.04
5-602	.90
5-604	1.00
5-620	.03
5-630	.03
5-640	.10
5-650	Discontinued
5-662	.12
5-669	.80
5-690	.04
5-698	.05
5-801	5.60
5-802	1.50
5-803	.10
5-805	.12
5-807	.86
5-808	.62
5-809	.52
5-810	.70
5-811	.40
5-812	.35
5-816	.16
5-867	.70
5-881	4.50
5-883	.42
5-884	1.50

PAGE 9

**Parts and Accessories
For Electric Lights**

20011	.22
20012	.82
20014	.22
20017	1.32
20019	2.76
20022	P.O.R.
20023	P.O.R.
20025	P.O.R.
20026	P.O.R.
20031	2.00

Part No. List Pr. Each

20034	.20
20037	P.O.R.
20040	.80
20046	.80
20049	1.00
20052	.80
20058	.30
20061	.15
20063	.60
20067	.75
20070	1.40
20073	1.00
20076	.10
20078	1.50
20079	2.00
20081	1.60
20082	1.80
20099	.27

20111	.40
20117	.60
20120	1.00
20123	1.00
20125	1.00
20129	.20
20132	.40
20135	3.00
20141	1.00
20147	.40
20150	.10
20153	1.00
20156	.40
20159	1.40
20164	.40
20167	.80
20170	.30
20173	.45
20179	.10
20182	.20
20194	.80
20197	1.00

20200	.60
20203	1.00
20204	.25
20206	1.40
20213	4.80
20214	5.40
20221	Pkg. 1.70
20224	Pkg. 1.70
20227	Pkg. 2.00
20230	Pkg. 2.00
20233	Pkg. 1.70
20236	Pkg. 1.70
20239	Pkg. 2.00
20242	Pkg. 2.00
20245	Pkg. 1.70
20248	Pkg. 1.70
20250	Pkg. 2.50
20251	Pkg. 1.70
20254	2.50
20257	2.85
20263	Pkg. 12.50
20264	Pkg. 12.50
20271	Pkg. 2.00
20274	Pkg. 2.00
20277	Pkg. 1.70
20293	Pkg. 5.00
20295	Pkg. 2.50
20099	Pkg. 2.70

20311	1.00
20314	1.00
20317	1.00
20320	1.20
20323	.10

Part No. List Pr. Each

20326	.15
20329	.50
20332	.40
20354	1.00
20357	2.00
20360	.50
20363	.90
20372	.20
20373	.20
20374	.20
20375	.20
20382	2.64
20383	2.64
20384	2.64
20385	2.64
20386	2.00
20391	.05
20394	.08
20397	.20

20400	.40
20421	.10
20424	.20
20427	.25
20430	.20
20433	.20
20441	.10
20447	.30
20450	.12
20453	.20
20461	.10
20467	.25
20470	.30
20473	.40
20481	.20
20487	.40
20490	1.00
20493	.80
20496	.40

20501	.50
20503	.10
20521	.05
20524	.05
20530	.10
20551	.25
20554	.60
20557	.10
20560	.30
20563	.30
20566	.30
20569	.30
20581	.35
20584	.50
20587	.80
20590	2.00
20593	.30
20596	.10

20611	.60
20614	.60
20617	.30
20620	.45
20625	.65
20626	.70
20628	2.40
20631	1.00
20634	2.20
20635	.20
20638	.20
20644	2.60
20661	.25
20664	.10
20667	.60
20670	.10
20673	1.80

JUSTRITE PRICE LIST NO. 590

NUMERICAL LIST OF NEW CATALOG NUMBERS WITH THE CORRESPONDING OLD NUMBERS

New Cat. No.	Old Cat. No.	Description	List Price Ea.	Ship. Wt. & Quan. () of Std. Pack	New Cat. No.	Old Cat. No.	Description	List Price Ea.	Ship. Wt. & Quan. () of Std. Pack
CARBIDE LAMPS									
2-500	2-50D	Hand Lamp	6.00	44# (24)	5-809	5-33A9	Belt, adj.	.52	
2-501	2-50E	Hand Lamp	6.40	44 (24)	5-810	5-88A10	Bulls Eye	.70	
2-561	2-56E	Hand Lamp	6.95	36 (24)	5-811	5-88A11	Dkn. Door	.40	
2-571	2-57E	Hand Lamp	7.45	26 (12)	5-812	5-88A8	Bulls Eye	.35	
					5-816	5-88A16	Retain, Wire	.16	
2-810	2-810R	Cap Lamp	3.40	7 (12)	5-867	5-67	Burner Tip	.70	
2-840	2-840R	Cap Lamp	3.70	8 (12)	5-881	5-88B1	Head Lamp	4.50	
2-844	2-840W	Cap Lamp	3.70	9 (12)	5-883	5-88B3	Reflector	.42	
2-870	2-870R	Cap Lamp	4.95	14 (12)	5-884	5-88B4	Tube & Tip	1.50	
2-888	2-88B	Head Lamp	12.80	2½ (1)					
Parts and Accessories for Carbide Lamps									
5-012	5-12	Carbide - 2 lbs.	1.15	59 (24)	9-100	9-1	6 Gallon	11.70	11# (1)
5-015	5-150	Wood Tube	.08		9-110	9-1A	Same - without foot lever	10.40	9 (1)
5-037	5-37	Tip Cleaner	.32		9-300	9-3	10 Gallon	12.50	14 (1)
5-075	5-75	Match Box	.40		9-310	9-3A	Same - without foot lever	11.40	12 (1)
5-128	5-28	Burner Tip	.10		9-500	9-5	14 Gallon	15.00	17 (1)
5-136	5-36H5	7" Refl'tr.	2.40		9-700	9-7	25 Gallon	28.00	25 (1)
5-158	5-158	Ferrule	.10		9-710	9-7A	Same - without foot lever	26.00	23 (1)
5-159	5-359	Valve Stm.	.40		9-910	9-9A	40 Gallon	36.00	36 (1)
5-172	5-172	Flint	.04						
5-173	5-173	Spring	.02						
5-174	5-174	Screw Cap	.04						
5-175	5-175	Wheel	.06						
5-176	5-176	Fork	.12						
5-177	5-177	Lighter Comp.	.25						
5-180	5-180	Protector	.10						
5-182	5-182	Hex. Nut	.02						
5-185	5-184	Water Door	.30						
5-197	5-197	Wing Nut	.10						
5-244	5-244	Canvas Cap	1.50						
5-245	5-245	Ream'r - Tube of 12	.80						
5-248	5-248	Ream'rs - Blk.	.07						
5-505	5-505	4" Refl'tr.	1.10						
5-510	5-51D	Bottom - Stl.	1.30						
5-511	5-51E	Bottom - Brass	1.80						
5-520	5-52	Felt	.05						
5-530	5-53	Flt. Holder	.15						
5-554	5-254	Refl. Brace	.05						
5-561	5-61	Gasket	.06						
5-600	5-60	Gasket	.04						
5-602	5-500	2½" Refl.	.90						
5-604	5-504	4" Refl'tr.	1.00						
5-620	5-62	Felt	.03						
5-630	5-63	Flt. Plate	.03						
5-640	5-64	Flt. Holder	.10						
5-650	5-65	Lamp Clip	Discontinued						
5-662	5-662	Rubber Grip	.12						
5-669	5-965	Bottom	.80						
5-690	5-190	Cap Spring	.04						
5-698	5-298	Refl. Brace	.05						
5-801	5-33A1	Generator	5.60						
5-802	5-33A2	Bottom	1.50						
5-803	5-33A3	Hose Pins, Per Pr.	.10						
5-805	5-88A5	3" Lens	.12						
5-807	5-88A7	Headstrap	.86						
5-808	5-33A8	Rubber Hose	.62						
OILY WASTE CANS									
					10000	1000	1 Pint	6.20	12 (6)
					10001	1001	Same, with screen	7.20	12 (6)
					10100	1010	1 Quart	6.40	14 (6)
					10101	1011	Same, with screen	7.40	14 (6)
					10108	1081	Plunger Can - 1 Qt.	7.50	32 (12)
					10162	10SS10	Stn'ls. Stl. - 1 Qt.	23.00	14 (6)
					10163	10SS11	Same, with screen	26.20	14 (6)
					10200	1020	½ Gallon	7.00	19 (6)
					10201	1021	Same, with screen	8.20	19 (6)
					10208	1082	Plunger Can - ½ gal.	7.90	36 (12)
					10300	1030	1 Gallon	7.20	24 (6)
					10301	1031	Same, with screen	8.40	24 (6)
					10308	1083	Plunger Can - 1 gal.	9.80	4 (1)
					10362	10SS30	Stn'ls. Stl. - 1 gal.	27.00	24 (6)
					10363	10SS31	Same, with screen	30.75	24 (6)
					10370	New	Bench Can	12.00	5 (1)
					10376	New	Drip Can	9.00	4½ (1)
					10400	1030-M	One Imperial Gallon	7.80	27 (6)
					10401	1031-M	Same, with screen	9.00	27 (6)
					10500	1040	2 Gallon	9.40	7 (1)
					10501	1041	Same, with screen	10.60	7 (1)
					10700	1050	3 Gallon	9.80	8 (1)
					10701	1051	Same, with screen	11.00	8 (1)
					10721	1056	Type 2 Can - 3 gal.	22.00	10 (1)
					10800	1060	5 Gallon	10.40	9 (1)
					10801	1061	Same, with screen	11.60	9 (1)
					10809	1068	Laboratory Can	25.00	10 (1)
					10820	1065	Type 2 Can - 5 gal.	21.00	12 (1)
					10821	1066	Same, with screen	23.00	12 (1)
					10849	1068-HT	Hot Tinned Lab. Can	34.00	10 (1)
					10862	10SS60	Stn'ls. Stl. - 5 gal.	39.00	9 (1)
					10863	10SS61	Same, with screen	42.75	9 (1)
					10869	10SS68	Stn'ls Stl. Lab. Can	52.00	10 (1)
					10900	New	5 Gal. Imperial Meas.	11.80	10 (1)
					10901	New	Same - with screen	13.00	10 (1)

JUSTRITE PRICE LIST NO. 590

(JUSTRITE CATALOG NUMBERS NOT SHOWN HERE WILL BE FOUND ON BACK PAGE)

New Cat. No.	Old Cat. No.	Description	List Price Ea.	Ship. Wt. & Quan. () of Std. Pack
Parts and Accessories for Safety Cans				
11001	10-P-1	Cover Assembly	1.00	
11002	10-P-2	Leather Washer	.20	
11004	10-P-4	Cover Spring	.20	
11007	10-P-7	Lever—1/2 & 1 gal. cans	.30	
11011	10-P-11	Handle, 2, 3 & 5 gal. cans	.70	

11021	10-P-21	Cover Assembly	.65	
11022	10-P-22	Leather Washer	.15	
11024	10-P-24	Cover Spring	.20	
11027	10-P-27	Operating Lever	.30	
11035	10-P-35	Air Vent	1.00	
11072	10-7-22	Screen set—Type 2	2.00	
11077	10-21-22	Hose—Type 2 Cans	2.40	
11088	1088	Hose Attach. - Type 1	3.80	
11096	New	Stn'ls. Stl. Screen	3.20	
11097	New	Stn'ls. Stl. Screen	3.75	
11098	1098	Screen—Cad. Plate	1.00	
11099	1099	Screen—Cad. Plate	1.20	
11150	10-A-50	Pan—Plunger Can	1.30	
11151	10-A-51	Adjusting Nut	.15	
11152	10-A-52	Plunger Spring	.10	
11157	10-A-57	Plunger Spring	.15	
11270	10-FM9	Safety Faucet	9.00	

LEAK DETECTORS

12360	1236	Detector	13.50	2# (1)
12463	12-1463	Flame Ring	.30	
12473	12-S-6	Handle	1.50	
12404	12-S-4	Base	1.40	
12406	12-S-7	Valve	1.20	
12497	12-S-33	Cleaner	.10	
12498	12-S-31	Burner Tip	.35	

FIRE EXTINGUISHERS

JUSTRITE FIRE EXTINGUISHERS HAVE BEEN DISCONTINUED. AN EQUIVALENT EXTINGUISHER AND PARTS FOR JUSTRITE EXTINGUISHERS ARE AVAILABLE FROM KENT EXTINGUISHER CO., GRAND RAPIDS, MICHIGAN.

SAFETY and SPECIAL LIGHTS

1704-8	1904-S	Headlight	9.95	14 (12)
1708-8	1958-S	Headlight	Discontinued	
1717-8	1717-S	Flashlight	5.75	7 (12)
1725-7	2125	Beach Landing Ltn.	P.O.R.	—
1729-8 15		Extn. Light, 15"	17.95	15 (12)
1729-8 30		Extn. Light, 30"	19.95	18 (12)
1729-8 SL		Extn. Light, Spl. Lgth.	P.O.R.	—
1730-7	17-A	Penlight	P.O.R.	—
1730-9	17N30	Penlight	P.O.R.	—
1739-7	New	Helicopter Lt.	P.O.R.	—
1740-7		Truck Ltn.	P.O.R.	—
1740-8		Truck Ltn.	P.O.R.	—
1744-7	2144-SB	Brass Ltn.	18.00	28 (12)
1744-8	2144-S	Safety Ltn.	8.95	27 (12)
1746-8	2146-S	Flashr. Ltn.	10.00	27 (12)
1788-8	2188-S	Hand Light	10.95	19 (12)

ELECTRIC HEADLIGHTS

1903-2	1996	Headlamp	4.30	8 (12)
1903-5	1958-T	Industrial Headl't.	6.25	18 (12)
1903-6	1958	Headlight	5.95	18 (12)

New Cat. No.	Old Cat. No.	Description	List Price Ea.	Ship. Wt. & Quan. () of Std. Pack
1904-2	1994	Headlamp	2.95	6# (12)
1904-4	1904	Headlight	4.95	12 (12)
1911-2	1911-2	Headlamp	3.50	6 (12)
1911-4	New	Headlight	5.50	11 (12)
1983-1	1983	Dualite, 3 cl.	6.95	19 (12)
1989-1	1995	Dualite, 5 cl.	8.95	26 (12)

Parts and Accessories (Nos. 20011 thru 20673) For Lights are listed below and on Page 3.

INDUSTRIAL and RAILROAD LANTERNS

2105-4	New	"Light Stick", 2 1/2" Refl.	5.95	10 (12)
2105-6	New	Same, Bell System only	5.95	10 (12)
2106-4	New	"Lt. Stick", 2 3/4" Refl.	P.O.R.	—
2107-6	2107-T	Belt Light	4.95	17 (12)
2108-6	2108-T	Hand Light, 2 1/2" Refl.	4.75	18 (12)
2219-2	New	Hand Light, 3" Refl.	5.95	10 (6)
2121-1	2121	Inspectors Lantern	8.95	24 (12)
2131-1	2131	Inspectors Lantern	7.50	20 (12)
2131-2	New	Same, Clear Lens	7.50	20 (12)
2140-1	2140	Trainmans Lantern	5.80	21 (12)
2140-3	2140-W	Same, With Lens	6.40	26 (12)
2140-5	2140-LR	Same, with red Fres. Lens	7.95	30 (12)
2141-2	New	Trainmans Lantern	5.80	21 (12)
2142-6	2142-W	Industrial Lantern	7.45	27 (12)
2151-1	New	Twin-Bulb "Light Stick"	P.O.R.	—
2155-1	New	Pocket Light, Less Batt.	2.25	—
2155-2	New	Pocket Light, With Batt.	2.70	—
2172-1	2172	Flagmn. Ltn., Less Globe	7.35	21 (12)
2172-2	2172-R	Flagmn. Ltn., & Red Globe	9.95	28 (12)
2172-3	2172-Y	Flagmn. Ltn., & Yel. Globe	9.95	28 (12)
2172-4	2172-G	Flagmn. Ltn. & Green Globe	9.95	28 (12)
2172-5	2172-B	Flagmn. Ltn. & Blue Globe	9.95	28 (12)
2172-6	2172-W	Flagmn. Ltn. & White Globe	9.00	28 (12)

GENERAL PURPOSE LANTERNS

2208-1	2108	8-Cell Fishlt, 2 1/2" Refl.	3.95	17 (12)
2209-1	2209	Yellow-Flash Sear.	5.95	18 (12)
2298-1	2198	8-Cell Twin-Bulb Lant.	5.95	26 (12)
2299-0	New	Fishermans Lantern	4.95	18 (12)
2301-3	New	"Light House" Warn. Lt.	4.25	12 (12)
2305-1	2305	V-6 Searchlight	4.75	12 (12)
2305-4	New	V-6 Red Warn. Lt.	5.25	12 (12)
2401-4	New	"Pendragon" Seal. Bm.	22.95	3 1/2 (1)
2401-5	New	Same, with connection	25.95	3 1/2 (1)
2404-3	New	"Pendragon", 2-Fm. Bulb	23.95	3 1/4 (1)
2404-5	New	Same, with Connection	25.95	3 1/2 (1)
2411-1	New	"Interceptor" Lantern	7.95	2 (1)
2411-6	New	"Interceptor" Lantern	8.95	1 1/2 (1)
2434-3	New	"Saddle-Light" 3" Refl.	P.O.R.	—
2434-4	New	"Saddle-Light" 4 1/2"	P.O.R.	—
2434-6	New	"Saddle-Light" Seal. Bm.	P.O.R.	—

Parts and Accessories for Electric Lights

20011	17-1101	Battery, AA	.22	2 (12)
20012	New	"Energizer", Size D. Batty.	.82	—
20014	20B14	Battery, D	.22	9 (48)
20017	20B7	Battery, Lant.	1.32	18 (12)
20019	New	Double-6, 6V. Batty.	2.76	
20022	New	4 Volt Storage Btty.	P.O.R.	
20023	New	6 Volt Storage Btty.	P.O.R.	
20025	New	Nickel-Cad. Btty., 4.8V	P.O.R.	
20026	New	Nickel-Cad. Btty., 6.0V	P.O.R.	

PRICES SUBJECT TO CHANGE WITHOUT NOTICE

JUSTRITE PRICE LIST NO. 590

(PARTS AND ACCESSORIES FOR ELECTRIC LIGHTS - CONT.)

New Cat. No.	Old Cat. No.	Description	List Price Ea.	New Cat. No.	Old Cat. No.	Description	List Price Ea.
20031	19-B2	Btty. Case	2.00	20326	20-A15	Retain. Wire	.15
20034	19-B3	Contact Pl.	.20	20329	21-N-73	Extender, 3/4"	.50
20037	New	Plastic Pouch	P.O.R.	20332	21-A14L	Extender, 1/2"	.40
20040	21-A95	Bottom	.80	20354	21-F29W	Gl. Cover, Fr., Wh.	1.00
20046	20-B86	Cover	.80	20357	21-F29R	Gl. Cover, Fr., Rd.	2.00
20049	21-A40	Cover	1.00	20360	21-A20	Lucite Cover	.50
20052	20-F80	Cover	.80	20363	21-A21	Lucite Cover, Red	.90
20058	21-A41	Cover	.30	20372	New	Bib. Cover, Red	.20
20061	21-A31	Latch Assy.	.15	20373	New	Bib. Cover, Yellow	.20
20063	20-F81	Contact Pl.	.60	20374	New	Bib. Cover, Green	.20
20067	21-A43	Bottom Assy.	.75	20375	New	Bib. Cover, Blue	.20
20070	21-A35	Case Sides	1.40	20382	2010-12	Fr. Globe, Red	2.64
20073	20-A13	Wire Seals, Pkg.	1.00	20383	2010-13	Fr. Globe, Yellow	2.64
20076	21-A44	Lever	.10	20384	2010-14	Fr. Globe, Green	2.64
20078	New	6-Volt Plate, 2401 & 04	1.50	20385	2010-15	Fr. Globe, Blue	2.64
20079	New	Insulator Pl.	2.00	20386	2010-11	Fr. Globe, Clear	2.00
20081	New	Cont. Plate, 2401-5	1.60	20391	21-A24	Gasket, 3/8"	.05
20082	New	Cover	1.80	20394	20-N74	Gasket, 2-13/16"	.08
20099	New	Flasher Bulb, 407	.27	20397	21-A25	Clips for Cover (3)	.20
20111	21-A71	Stand, Round	.40	20400	20-N75	Clamp for 2172	.40
20117	21-A74	Stand, Lng. Rnd.	.60	20421	1704	Lens, 2 1/2"	.10
20120	21-A73	Fixed Guard	1.00	20424	1703	Pl. Lens, 2 1/2"	.20
20123	21-A54	Stand, Movabl.	1.00	20427	1716	Honeycomb Lns.	.25
20125	New	Stand for 2121, 2131	1.00	20430	20-04R	Red Disc.	.20
20129	21-A75	Rivets, doz.	.20	20433	20-04	Discs—other clr.	.20
20132	21-A48	Bolts, Washers	.40	20441	2292	Lens, 3 3/4"	.10
20135	New	Light Shield	3.00	20447	New	Honeycomb Lns.	.30
20141	21-A46	Handle, Lg.	1.00	20450	20-07R	Red Disc, 2 3/4"	.12
20147	21-A45	Parts for Handl.	.40	20453	New	Discs, other clr.	.20
20150	21-A65	Wire Bail	.10	20461	19-F4	Lens, 3"	.10
20153	21-A51	Handle	1.00	20467	New	Honeycomb Lns.	.25
20156	New	Lanyard for Penlight	.40	20470	New	Red Disc., 3"	.30
20164	20-B10	Cord, 18 ga.	.40	20473	New	Discs, other clr.	.40
20167	20-F20	Cord, "SJ"	.80	20481	New	Lens, 3 3/4"	.20
20170	New	Headband	.30	20487	New	Lens, 4 1/2"	.40
20173	20-B11	Headband	.45	20490	New	Plastic Lns., 4 1/2"	1.00
20179	20-B12	Head Pad	.10	20493	New	Honeycomb Lns.	.80
20182	19-B7	Hook	.20	20496	New	Discs, spy. color	.40
20194	21-A57	Bracket	.80	20501	21-A90	Cylindrical Lns.	.50
20197	21-A60	Holder	1.00	20503	21-A91	Lining, Spy. col.	.10
20200	21-A62	Holder	.60	20521	New	Ret. Wire, 2 1/2"	.05
20203	21-A77	Holder	1.00	20524	1705	Saft. Ret. Wire	.05
20204	21-A79	Spring Arm	.25	20530	19-F5	Ret. Wire, 3"	.10
20206	21-A78	Holder	1.40	20551	20-F78	Ring, 2 1/2"	.25
20209	21-H30	Holder	P.O.R.	20554	20-F78S	Ring Assy., Saft.	.60
20213	New	Bracket for 2401-2404	4.80	20557	New	Ring, 2 3/4"	.10
20214	New	Same, Padlock type	5.40	20560	19-F6	Ring, 3"	.30
20221	17-1102	Bulb 222	Pkg. 1.70	20563	New	Ring, 4 1/2"	.30
20224	New	Bulb, No. 243	Pkg. 1.70	20566	20-34	Collar, 2 1/2"	.30
20227	New	Bulb PR 7	Pkg. 2.00	20569	New	Collar, 3"	.30
20230	New	Bulb PR 3	Pkg. 2.00	20581	21-A42	Refl., 3 1/2"	.35
20233	New	Bulb 13	Pkg. 1.70	20584	New	Spl. Refl.	.50
20236	1701	Bulb 365	Pkg. 1.70	20587	21-N70	Refl., 3 1/4"	.80
20239	New	Bulb PR 17	Pkg. 2.00	20590	21-A30	Refl., 7"	2.00
20242	20-A6	Bulb PR 13	Pkg. 2.00	20593	21-A27	Screws (3)	.30
20245	20-A1	Bulb 502	Pkg. 1.70	20596	21-A26	Screws (3)	.10
20248	20-A2	Bulb 27	Pkg. 1.70	20611	20-F57	Refl., Sfty. 2 1/2"	.60
20250	New	Bulb, No. 1403	Pkg. 2.50	20614	1707	Refl., 1717-8	.60
20251	20-A5	Bulb No. 425	Pkg. 1.70	20617	20-F79	Refl., 2 1/2"	.30
20254	20-All	Sl. Beam 4546	2.50	20620	New	Refl., 2 3/4"	.45
20257	New	Sl. Beam 4547	2.85	20625	New	Refl., 3", for 2131	.65
20263	New	Bulb 1553	Pkg. 12.50	20626	19-F7	Refl., 3"	.70
20264	New	Bulb 1554	Pkg. 12.50	20628	New	4 1/2" Reflector	2.40
20271	New	Bulb PR 12	Pkg. 2.00	20631	New	D.C. Socket, 2404	1.00
20274	New	Bulb 31	Pkg. 2.00	20634	New	Spl. Refl. 2404	2.20
20277	20-05	Bulb 605	Pkg. 1.70	20635	New	Cup & Spring	.20
20293	20-A7	Bulb 993	Pkg. 5.00	20638	New	Cup & Socket	.20
20295	20-A9	Bulb 965	Pkg. 2.50	20644	New	Pl. Sld. Refl., 4 3/8"	2.60
20099	New	Flash. Bulb, 407	Pkg. 2.70	20661	1709	Switch	.25
20311	21-A36	Socket Slide	1.00	20664	1710	Cont. Spring	.10
20314	21-A38	Socket Slide	1.00	20667	1715	Bottom Cover	.60
20317	21-A37	Socket Slide	1.00	20670	17E20	Bib. Protector	.10
20320	21-N29	Socket Slide	1.20	20673	1719	Assy. 1729-8	1.80
20323	1702	Retain. Wire	.10				

PRICES SUBJECT TO CHANGE WITHOUT NOTICE

CONVERSION LIST OF OLD CATALOG NUMBERS

SHOWING CURRENT EQUIVALENTS FOR NUMBERS FORMERLY USED

Former Catalog Number	Current Number or Replacement	Former Catalog Number	Current Number or Replacement	Former Catalog Number	Current Number or Replacement
JUSTRITE CARBIDE LAMPS		1082	10208	44-SN	1744-7
		1083	10308	51-W	1744-8
2-50D	2-500	1088	11088		
2-50E	2-501	1098	11098	2101	2208-1
2-55A	Discontinued	1099	11099	2103	Replaced by No. 2209-1
2-56E	2-561	10-FM9	11270	2104	Replaced by No. 2305-1
2-57E	2-571	10SS10	10162	2104-R	2305-4
2-88B	2-888	10SS11	10163	2107-T	2107-6
2-335	Discontinued	10SS30	10362	2108	2208-1
2-375	Replaced by No. 2-571	10SS31	10363	2108-T	2108-6
2-810R	2-810	10SS60	10862	2108-U	2208-1
2-830R	Replaced by No. 2-840	10SS61	10863	2111	Replaced by No. 2131-1
2-840R	2-840	10SS68	10869	2111-Q	Replaced by No. 2131-1
2-840W	2-844			2115	Discontinued
2-850R	Use No. 2-840 with Headstrap No. 5-807	JUTRITE LEAK DETECTOR		2121	2121-1
		1236	12360	2125	1725-7
2-870R	2-870			2130-S	1740-8
				2130-SHB	1740-7
5-22	Replaced by No. 5-037	JUSTRITE FLASHLIGHTS, ETC.		2134-1	Discontinued
5-23	Discontinued	17-A	1730-7	2137	See No. 1739-7
5-37	5-037	17-S	1717-8	2138	See No. 1739-7
5-77	Discontinued	17N30	1730-9	2139	1739-7
5-170	Replaced by No. 5-172	17J31	1730-9	2140	2140-1
5-243	Replaced by No. 5-244	1704-7	Replaced by No. 1704-8	2140-2	2140-1
5-868	Replaced by No. 5-867	1717-S	1717-8	2140-LR	2140-5
		1727-S-15	1729-8 (15")	2140-LW	2140-3
JUSTRITE OILY WASTE CANS		1727-S-30	1729-8 (30")	2140-P	2140-1
9-1	9-100	1727-S-*	1729-8 (Spl. Lengths)	2140-W	2140-3
9-1A	9-110	1727-8	1729-8 (15")	2142-W	2142-6
9-2	Replaced by No. 9-300	1728-8	1729-8 (30")	2144-S	1744-8
9-3	9-300	1731-7	1730-9	2144-SB	1744-7
9-3A	9-310	1737-7	See No. 1739-7	2146-S	1746-8
9-5	9-500	1738-7	See No. 1739-7	2147-6	Discontinued
9-5A	Discontinued			2150	Replaced by No. 2141-2
9-7	9-700	JUSTRITE ELECTRIC HEADLIGHTS		2158-6	1903-5
9-7A	9-710	32-N	1904-4	2172	2172-1 (When Lens is required please specify color).
9-9A	9-910	83-AC	1983-1		
				2188-S	1788-8
JUSTRITE SAFETY CANS		1904	1904-4	2190	Order No. 2301-3 with No. 20501 Lens and Bulb No. 27.
1000	10000	1904-S	1704-8	2191	Order No. 2301-3 with No. 20501 Lens and Bulb No. 27
1001	10001	1904-SB	Replaced by No. 1704-8		
1010	10100	1911-1	1911-2	2192	2301-3
1011	10101	1911-6	Discontinued	2192-A	Replaced by No. 2301-3
1020	10200	1955	1903-5	2198	2298-1
1021	10201	1958	1903-6	2198-L	Replaced by No. 2142-6
1030	10300	1958-S	Discontinued	21WW	Discontinued
1030-M	10400	1958-T	1903-5		
1031	10301	1983	1983-1		
1031-M	10401	1987	Replaced by No. 1989-1	2209	2209-1
1040	10500	1989	1989-1	2209-2	Replaced by No. 2209-1
1041	10501	1994	1904-2	2302-1	Order No. 2301-3 with No. 20501 Lens and Bulb No. 27
1045	Discontinued	1995	1989-1		
1046	Discontinued	1996	1903-2		
1050	10700			2302-4	2301-3
1051	10701	JUSTRITE ELECTRIC LANTERNS		2305	2305-1
1055	Replaced by No. 10721	40	2140-1	2305-2	Replaced by No. 2305-1
1056	10721	40W	2140-3	2306-2	Discontinued
1060	10800	40R	Order No. 2140-3 with No. 20363 Red Globe	2401-1	Replaced by No. 2401-4
1061	10801			2402-5	Replaced by No. 2404-3
1065	10820	42W	2142-6	2404-1	2404-3
1066	10821	44-S	1744-8	2404-2	Replaced by No. 2404-3
1068	10809	44-SB	1744-7	2412-5	Discontinued
1068-HT	10849				
1081	10108				