

JUSTRITE

Catalog NO. 481

P and G SERVICE CORPORATION
30 No. La Salle St. Chicago.
PB. Randolph 6-2117



CONTENTS

	Page Nos.		Page Nos.
SAFETY GASOLINE CANS.....	2	RAILROAD LANTERNS	5, 6
OILY WASTE CANS.....	3	ELECTRIC HEADLIGHTS.....	7
SAFETY FILLING CANS.....	3	SPORTSMEN'S ELECTRIC LIGHTS.....	4, 5, 6, 7
SAFETY LANTERNS (Approved).....	4, 5, 6	CARBIDE LAMPS.....	11, 12
SAFETY FLASHLIGHTS (Approved).....	8	SOLDERING SETS.....	9
LEAK DETECTORS (Refrigeration).....	10		

JUSTRITE SAFETY CANS

The Safe and Economical Way to Handle and Store Flammable Liquids

Approved, Inspected and Individually Numbered and Labeled by Underwriters' Laboratories, Inc.

Approved by the Associated Factory Mutual Fire Insurance Companies, and so stamped.

NEW YORK CITY FIRE DEPT.
Approval No. 92.

EFFICIENT — NO WASTE — NO LEAKAGE

Easy to Pour—"Pouring Lip" on outer rim of nozzle enables contents to be poured without spilling. On 2 Gal. to 5 Gal. sizes, the "Swinging" Handle, an exclusive Justrite feature (Patent No. 1954983), makes a can easy to handle and pour. Balances load for carrying.

Spout Cap—Controlled by a strong, non-rusting spring which holds cap closed tight, preventing leakage and evaporation. If can is exposed to extreme heat, this spring permits excessive gas pressures to escape and automatically closes the cap when pressure is relieved.

Large Nozzles—Easy to fill and empty—no funnel needed.

Rounded Dome—No channel above the seam to catch dirt or liquid.

Strong Construction—Body: heavy, coated 24-gauge steel (on 1 Pt. and 1 Qt., 26-gauge) double seamed and soldered. Bottoms on 2, 3, 5 gallon sizes are reinforced by a steel ring.

Finish—All sizes are finished in a high-gloss red enamel—baked on.

Safety Screen—Non-flash-back or Baffle Screens are available in any Justrite Safety Can (as shown on price list). Screens are of the most efficient and strongest type, made of two layers of wire mesh.

Screens are not required by Underwriters' Laboratories, Inc., but are required by Associated Factory Mutual Fire Insurance Companies in the 1, 2, 2-1/2, 3 and 5 gallon sizes. They can be inserted or removed without special tools.



1 Pint

1 Quart

1/2 Gallon

1 Gallon

See Illustration of 2-1/2 Gallon Can at Bottom of Page



2 Gallon

3 Gallon

5 Gallon

SPECIFICATIONS

Cat. No.	Capacity	Diameter Ins.	Height Ins.	Nozzle Opening Ins.	SHIPPING CARTON Number	Shipping Wgt. Lbs.
WITH "TRIGGER" HANDLE						
1000	1 Pt.	4-5/8	6-3/4	1	6	13
1001	1 Pt.—Same	equipped with Safety, Non-Flash-Back Screen		1	6	13
1010	1 Qt.	4-5/8	8-1/4	1	6	14
1011	1 Qt.—Same	equipped with Safety, Non-Flash-Back Screen		1	6	14
1020	1/2 Gal.	7-1/4	8-3/8	1-5/8	6	19
1021	1/2 Gal.—Same	equipped with Safety, Non-Flash-Back Screen		1-5/8	6	19
1030	1 Gal.	7-1/4	11-1/2	1-5/8	6	24
1031	1 Gal.—Same	equipped with Safety, Non-Flash-Back Screen		1-5/8	6	24

WITH "SWINGING" HANDLE

1040	2 Gal.	9-3/8	12-5/8	1-5/8	1	7
1041	2 Gal.—Same	equipped with Safety, Non-Flash-Back Screen		1-5/8	1	7
1045	2-1/2 Gal.	11-1/2	12	1-5/8	1	8
1046	2-1/2 Gal.—Same	equipped with Safety, Non-Flash-Back Screen		1-5/8	1	8
1050	3 Gal.	9-3/8	16-1/8	1-5/8	1	8
1051	3 Gal.—Same	equipped with Safety, Non-Flash-Back Screen		1-5/8	1	8
1060	5 Gal.	11-1/2	17	1-5/8	1	9
1061	5 Gal.—Same	equipped with Safety, Non-Flash-Back Screen		1-5/8	1	9

SAFETY (NON-FLASH-BACK) SCREENS Complete with Lock-Wire to Lock Screen in Can

1098	Screen—	for 1 Pint and 1 Quart Cans
1099	Screen—	for 1/2 Gal., 1 Gal., 2 Gal., 2-1/2 Gal., 3 Gal. and 5 Gal. Cans

FLEXIBLE HOSE ATTACHMENT FOR SAFETY CANS

EASIER, FASTER-POURING—FOR FILLING TANKS, ETC.

The Flexible Hose Attachment is easily fastened (by one bolt) to any Justrite Safety Can of 1/2 gallon or larger capacity. Steel bracket holds it solidly in place. Flexible hose can be moved to any angle or turned in any direction for convenience in pouring. Friction washers hold cup of hose at angle desired. Friction can be adjusted as required.

Non-sparking brass cup is 3" diameter, 2-1/2" deep—contains removable brass screen (100 mesh). Flexible, galvanized steel hose is 9-1/2" long, 3/4" O.D., has brass ferrule tip.

This attachment does not impair safety features of the can as the spout cap is free to operate at all times at any position of the attachment.

No. 1088 Flexible Hose Attachment with brass screen strainer and fastening bolt.... Wt. 2 lbs.....



2-1/2 Gallon Safety Can with Flexible Hose Attachment

JUSTRITE SAFETY FILLING CANS

Approved and Listed by Underwriters' Laboratories, Inc.
 Approved by Associated Factory Mutual Fire Insurance Companies.

For handling gasoline and other flammable liquids that must be poured into fuel tanks, etc., with minimum fire risk.

Easy, rapid pouring without "back-pressure". Air vent assures steady, even flow. No "spilling". Metal spout hose can be turned in any direction. No funnels needed.

Separate large filler opening is easily filled from hose of gasoline pump. Cover acts as vapor escape valve which relieves excess inside pressures.

"Swinging" handle balances load for carrying. Held in forward position when not in use. Pulling handle back opens valve to allow liquid to flow into hose. Flexible hose is 12" long, 1" O.D., removable.

Non-flash-back screens are available for either size and are required by Factory Mutuals' approval.

- 1055 3 Gal. Capacity . . 11-1/2" Diam. . . 12-1/8" High . . Wt. 10 lbs. . .
- 1056 Same—with Safety Screens
- 1065 5 Gal. Capacity . . 11-1/2" Diam. . . 16-5/8" High . . Wt. 12 lbs. . .
- 1066 Same—with Safety Screens
- 10-7-22 Set of Safety Screens (2) with Lock Wires for Safety Filling Cans



JUSTRITE OILY WASTE CANS

Approved, Inspected and Individually Numbered and Labeled by Underwriters' Laboratories, Inc.

Approved by the Associated Factory Mutual Fire Insurance Companies, and so marked.

SAFETY PLUS EFFICIENCY

Justrite Oily Waste Cans are especially made to hold oily waste, rags and all kinds of flammable materials. Cover on can opens to 60 degree angle—closes automatically when cover is released. A handle for carrying is conveniently located on top of can. Completely portable—Justrite Oily Waste Cans are easily moved to the most important locations throughout the plant.

STRONGLY CONSTRUCTED—ECONOMICAL

Justrite Oily Waste Cans are made to the specifications of the Underwriters' Laboratories, Inc. They are strongly constructed to give many years of service. The body is made of No. 24 gauge galvanized sheet steel, the Cover No. 22 gauge. Legs and handles are 1/8" band iron (one-inch in width). The can is double-seamed and soldered.



JUSTRITE Oily Waste Can with Foot Lever

SPECIFICATIONS AND SIZES

WITH FOOT LEVER

Catalog No.	Size exclusive of legs (Legs 4 in. high)	Nominal Capacity	Approx. Ship. Weight
9-1	11-3/4 x 13	6 gallon	14 lbs.
9-2	12-1/2 x 14	8 gallon	15 lbs.
9-3	13-1/2 x 15	10 gallon	17 lbs.
9-5	15-1/2 x 17	14 gallon	21 lbs.

WITHOUT FOOT LEVER

For those desiring a lower-priced Oily Waste Can, we can furnish a Justrite Oily Waste Can without foot lever attachment. In this can the cover is lifted by hand. Other features remain the same. The same Underwriters' Laboratories, Inc. approval and the same Associated Factory Mutual Fire Insurance Companies approval apply.

Catalog No.	Size exclusive of legs (Legs 4 in. high)	Nominal Capacity	Approx. Ship. Weight
9-1A	11-3/4 x 13	6 gallon	12 lbs.
9-2A	12-1/2 x 14	8 gallon	13 lbs.
9-3A	13-1/2 x 15	10 gallon	15 lbs.
9-5A	15-1/2 x 17	14 gallon	19 lbs.



Without Foot Lever

JUSTRITE "TWIN-BULB" ELECTRIC LANTERNS

"TWIN-BULB" DESIGN MEANS GREATER SAFETY—MORE EFFICIENCY—BETTER VISIBILITY

Exclusive "Sliding Bulb" Action—"Spot" Beam Plus Light to Sides

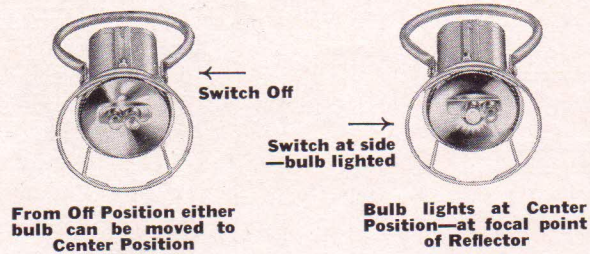

Two bulbs always available. If one burns out, the light can be restored instantly by moving the switch. The lighted bulb is always at center of the reflector. Either bulb gives a forward "spot" plus direct light around the lantern (light for distance plus light for the immediate vicinity).

Twin-Bulb Electric Lanterns use the standard lantern battery (6 volt) and two 5 volt bulbs (Mazda No. 502 or No. 27). The square case holds battery securely—avoids "rattle".

ALL-PURPOSE SAFETY LANTERNS

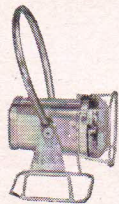

"Triple-Approved" Safety Lantern (see note below). Pivots on base to any angle. Wide movable handle made of aluminum tubing, reinforced, and covered with plastic insulating jacket. Movable base and wire guard over reflector are brass. 3-1/2" chrome reflector. Weight 2-1/2 lbs., height 12", width, at handle, 6-1/2".

No. 2144-S Safety Lantern with glass globe, sealing wires and two bulbs, less battery....

BRASS SAFETY LANTERN

Same as No. 2144-S but made entirely of brass. Polished finish. Recommended for uses requiring a more completely spark proof or non-corrosive lantern.

No. 2144-SN Brass Safety Lantern with Bulbs, less Battery....

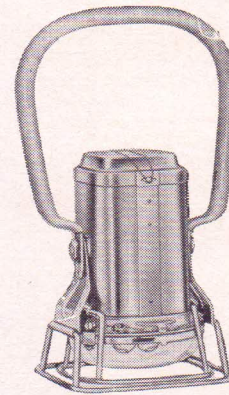

No. 2144-S

STANDARD "TWIN-BULB" LANTERNS "De Luxe" Model

The finest electric hand lantern. Finished in black enamel and chrome plate. Yellow insulated handle. 3-1/2" chrome reflector. Has attachment to provide a red beam from one bulb. Weight 2 lbs. Unconditionally guaranteed. Body of lantern pivots to any angle.

No. 2152 "De Luxe" Lantern with Globe and Bulbs, less Battery....

No. 2142-W same as above but has Plated, Unpolished Case and Aluminum Handle without Insulation. Does not have Red Beam Feature. Furnished with Glass Globe, Two Bulbs, less Battery....

Standard Safety Lantern

No. 2142-SAB same as No. 2142-W but is Triple-Approved for Safety (see note below). Has Brass Guard. Shatterproof Lucite Globe. Weight 2 lbs....

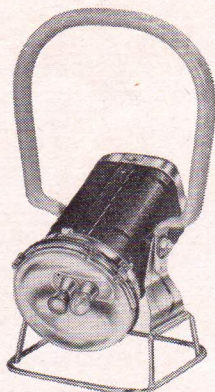

No. 2152

IMPORTANT NOTE—APPROVED SAFETY LANTERNS

Justrite Electric Lanterns and Flashlights which include the letter "S" in their catalog numbers are designed for use in gaseous atmospheres and have been tested and approved as follows:

Approved and listed by the Underwriters' Laboratories, Inc., for use in Class 1, Group D. locations. Approved by the U. S. Bureau of Mines (Approvals Nos. 1017 and 608). Approved by the U. S. Coast Guard Merchant Marine Technical Division—for pump rooms of tank vessels.

All Justrite Safety Lanterns and Flashlights are equipped with the "Kick-Out" bulb socket which holds the bulb in position against a strong ejection spring. If a bulb breaks, it is immediately ejected from the socket thereby eliminating the possibility of a spark across the bulb filaments that could ignite an explosive mixture.

Justrite Safety Lanterns are strongly constructed, to take hard use. Protruding parts are made of brass or are otherwise sparkproofed. A globe or lens is used to protect the "Kick-Out" bulb sockets.



JUSTRITE RAILROAD LANTERNS

"TWIN-BULB" TRAINMAN'S LANTERN

Has 3-1/2" chrome plated (on brass) reflector. One bulb socket will provide powerful spot beam. Other bulb extended for ordinary signals. Handle is aluminum tubing, reinforced with inserted steel, allows clearance for hand at side of battery case. Clearance over cover, 4". Handle may be moved to any position around lantern, locks in place by thumb screw. Welded steel guard. Carries two spare bulbs. Made of steel, zinc-chrome plated. Weight 2 lbs.

No. 2140 less Bulbs, less Battery

No. 2150. Same as No. 2140 but with Chrome Plated Case and Guard. Highly Polished. Plastic Insulation Covering Handle

No. 2141-N. "Twin-Bulb" Trainman's Lantern made entirely of Brass, Polished. Has Insulated Handle. Small Guard. Does not have extended Bulb Socket. Less Bulbs, less Battery. (No. 2141-N may be used with Globe. See Parts List, Page 8)

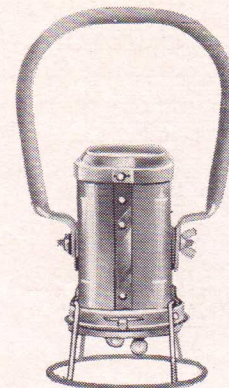

No. 2140

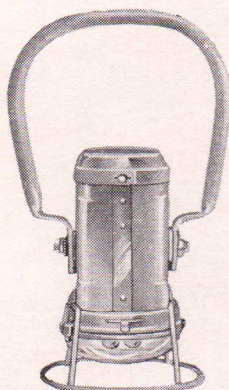

No. 2140W

TRAINMAN'S LANTERN WITH GLOBE (LENS)

No. 2140-W. Same as No. 2140 but with Glass Globe over Reflector. Does not have extended Bulb Socket. Furnished less Bulbs, less Battery. Weight 2-1/2 lbs.

APPROVED SAFETY LANTERN

No. 2140-S. Approved Safety Lantern (see note Page 4). Same as No. 2140-W but with Safety Bulb Sockets, Brass Guard and Yellow Insulated Handle. With Two Bulbs, less Battery

TWO BULB SIGNAL LANTERNS

Provides a signal beam—to all directions (through 360°). For railroad switchmen, flagmen, for traffic protection, for general signaling. Specially designed fresnel globe throws strong "pencil" beam, with maximum visibility. Has bulb and emergency bulb mounted under globe. Welded steel guard, movable handle, 14" high, 6-1/2" wide, over-all. Weight 3-1/2 lbs.

- 2171-JR Signal Lantern with Red Fresnel Globe, less Bulbs, less Battery
- 2171-JW Signal Lantern with White Fresnel Globe, less Bulbs, less Battery
- 2171-JB Signal Lantern with Blue Fresnel Globe, less Bulbs, less Battery
- 2171-JY Signal Lantern with Yellow Fresnel Globe, less Bulbs, less Battery

The special fresnel glass signal globes may be purchased separately: (Wgt. 8 ozs.)

20R70	Red Fresnel	20B70	Blue Fresnel
20W70	White (clear) Fresnel	20Y70	Yellow Fresnel

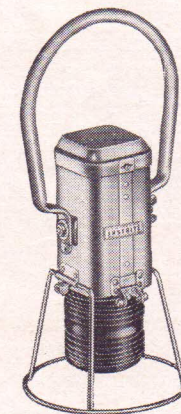

No. 2171-JR

JUSTRITE CAMP AND FARM LANTERN

New! It's the modern (battery-operated) version of the old, reliable oil lantern. A brilliant, clean electric light in place of the oil flame. The best kind of light for:

Barn	Night Fishing	Picnics
Yard	Small Boats	Beach Parties
Spring House	Dock "Marker"	Summer Porch
Basements	Tents	House Trailers
Closets and Attics	Camp Grounds	Trail "Marker"

Replaces hazardous oil lanterns. Uses standard lantern battery. Gives light to all sides in a wide, even band (not a spot beam). Reflectors above and below bulb distribute light with maximum efficiency. Unbreakable globe. Welded wire base. Movable wire bail. 13-1/2" high.

No. 2191, with Bulb and Spare Bulb, less Battery Wgt. 2 lbs.

No. 20-M10. Extra clear Plastic Globe for above Wgt. 2 ozs.

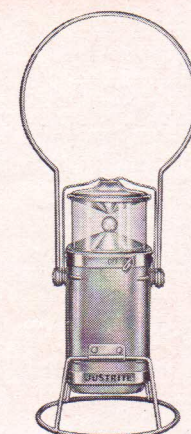

No. 2191

LANTERNS WITH 2½-INCH (Spot Type) REFLECTOR

INTERCHANGEABLE LENSES—FOR SPREAD BEAM OR "SPOT" LIGHT

Justrite Electric Hand Lanterns with the 2-1/2" reflector are designed to provide a concentrated beam of light. Because of its depth, the 2-1/2" reflector encloses the bulb and the available light is brought together before it passes through the lens.

When a clear lens is used in these lanterns, the light makes a "spot" beam of small diameter. By using the new Justrite Honeycomb Lens, this light can be spread over a much larger area. When the Honeycomb Lens is substituted for the ordinary lens, the diameter of the light beam provided by the lantern will be **increased three times**. Some of the Justrite Lanterns with the 2-1/2" reflector are regularly furnished with clear glass lenses. Others are supplied with the Honeycomb Lens. The lenses are interchangeable and may be purchased separately:

- No. 1704 Glass Lens (clear)
- No. 1716 Honeycomb Lens

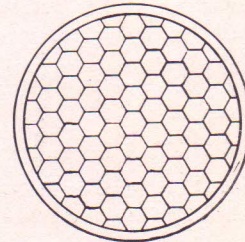

Honeycomb Lens

INSPECTOR'S LANTERN

Has two independent lens housings, one with spread-beam Honeycomb Lens, one with plain lens for spot beam. Independent switches. The two 2-1/2" reflectors and the lenses are interchangeable. Fixed, wood grip handle. Lantern pivots on base to any angle.

No. 2121 Double Head Inspector's Lantern with Two Bulbs, less Battery. Weight 2-1/4 lbs. . . .

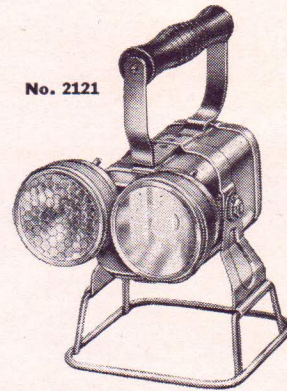

No. 2121

APPROVED SAFETY INSPECTOR'S LANTERN

No. 2121-S. Same as No. 2121 but approved for safety. Has Safety Bulb Sockets and Brass Guard (see note Page 4.) Can be supplied with Bail Handle as illustrated. With Bulbs, less Battery

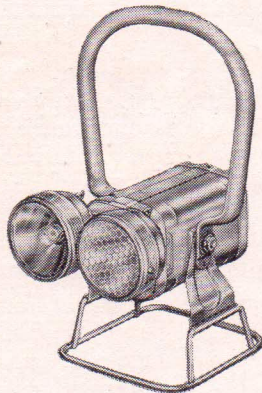

No. 2121-S

SINGLE HEAD INSPECTOR'S LANTERN

No. 2111. Same as No. 2121 but has One Lens Housing only. With Honeycomb Spread-Beam Lens. Weight 2 lbs. With Bulbs, less Battery

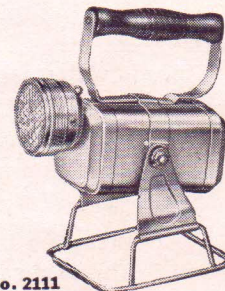

No. 2111

GENERAL UTILITY LANTERN

The most compact lantern using the standard lantern battery. Only 7-1/2", over-all. Fits in automobile glove compartment, tool box or overall pocket. Easy to carry—has folding wire handle and belt hook. Lens housing can be turned horizontally and vertically—to any direction, at any angle. Gives spot beam. Can also be used with Honeycomb Lens (above). Black enamel and bright metal finish.

No. 2101 with Bulb, less Battery Weight 1-1/4 lbs. . . .

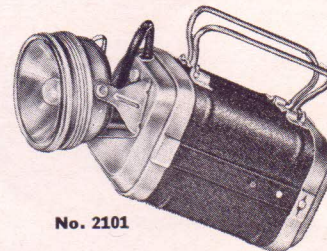

No. 2101

BELT LANTERN

Same design as No. 2101 (above) but has brackets to hold belt instead of folding handles. Worn on waist belt in position shown. Furnished with spread-beam Honeycomb Lens. Plated, bright metal finish.

No. 2107 with Bulb, with Waist Belt, less Battery Weight 1-1/2 lbs. . . .

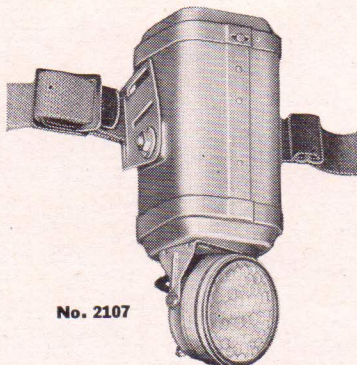

No. 2107

LANTERNS WITH 2 1/2-INCH REFLECTOR (Cont.)

FLEXIBLE LIGHT LANTERN

The Industrial Head Light. The separate head piece can be worn around the head, fastened to the wrist, to the leg, or on the shoulder strap or belt. Battery case is carried by shoulder strap and belt. Rubber connecting cord is 4 ft. long. Headpiece is mounted in a swivel bracket to permit adjusting the light-beam horizontally and vertically—to direct it exactly where required. Switch is mounted on headpiece in most accessible position. Weight 1-1/2 lbs.



1955 With Spot Lens, Bulb, Shoulder Strap and Waist Belt, less Battery . . .

19H55 Same with Spread-Beam Honeycomb Lens . . .

1936 No. 1955 Without Waist Belt or Shoulder Strap, less Battery . . .

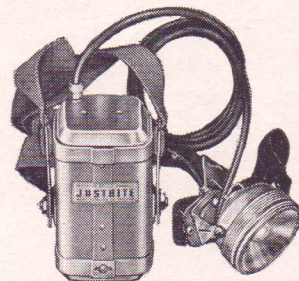

No. 1955

JUSTRITE ELECTRIC HEADLIGHTS and FLASHLIGHTS (For Use with Standard Flashlight Cells)

DUAL-PURPOSE HEADLIGHT LANTERNS

5-cell combination headlight and hand lantern. Converts to headlight by use of elastic headband and connecting cord concealed in chamber inside case. Handle slides down into case, case clips on belt. Has 3" reflector, 6.2 volt bulb. Gives spot beam about 1500 ft. Attractively finished in black crackle enamel and chrome plate. Size (as illustrated) 7-3/4" x 6" x 1-1/2".

No. 1995 Headlight Lantern with Bulb, less Batteries . . . Weight 1-3/4 lbs. . . .

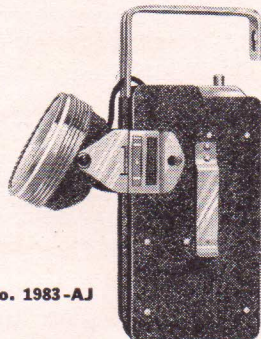

No. 1983-AJ

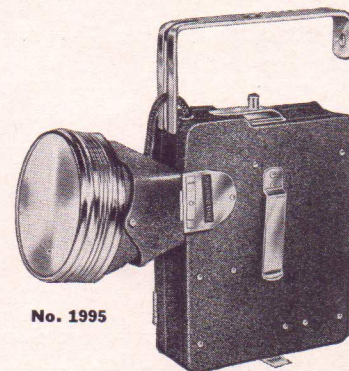

No. 1995

3-CELL HEADLIGHT LANTERN

No. 1983-AJ. Same "Dual-Purpose" design as No. 1995 (above) but uses only 3 flashlight batteries. 2-1/2" reflector. Has black crackle enamel and bright metal finish. Size 6" x 5" x 1-1/2". Weight 1-1/4 lbs. . . .

4-CELL ELECTRIC HEADLIGHT

For all purposes requiring both hands free. Headpiece fastens around head on adjustable elastic band, pivots to angle required. Switch mounted on headpiece. 2-1/2" polished reflector. Battery case (5-1/2" x 2-3/4" x 1-1/2") holds four standard cells, can be clipped on belt or carried in pocket. Finished in black enamel and bright metal plating.

No. 1904 with two 5-Volt Bulbs, less Batteries . . . Weight 1 lb. . . .

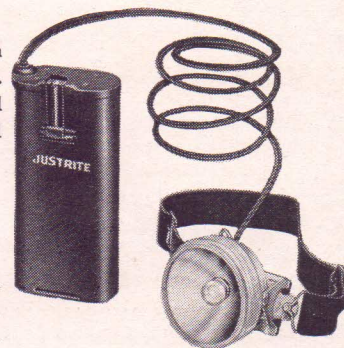

No. 1904

HEADLAMP ASSEMBLY—WITH SWITCH

No. 1994. No. 1904 Headlight less Battery Case. This Headlamp Assembly is used with special Dry Batteries such as the "Hot Shot" Battery or four No. 6 cells. Furnished with elastic headband, 4 ft. cord with Terminals and 5-Volt Bulb. Weight 8 ozs. . . .

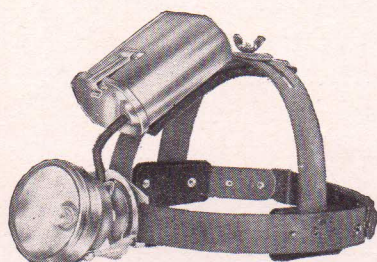

No. 1902

MECHANIX HEADLITE

Convenient in garages, filling stations, etc. Put on or removed quickly with one hand. Adjustable fiber straps (around and over top of head) hold headpiece and 2-cell battery case. Comfortable to wear—adjusts to fit head—needs no readjustment—has sponge rubber pads between straps and head. Headpiece swivels vertically and horizontally—permitting precise focusing on work.

No. 1902 with Bulb, less Batteries . . . Wgt. 1-1/2 lbs. . . .

3-CELL APPROVED SAFETY FLASHLIGHT

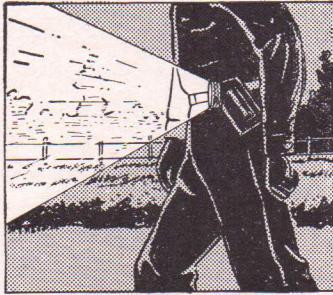

"Triple-Approved" for safety (See note, Page 4). Powerful beam. 2-1/2" highly polished reflector. Compact—pocket size—only 5-3/4" high (3" wide, 1-1/2" deep) yet holds 3 standard cells. Stands on base. Has carrying ring on bottom. Belt hook on side. Case is plastic molded in one piece and reinforced with inserted metal. Guaranteed against any breakage in ordinary use.

No. 1717-S, with Bulb and Spare Bulb, less Batteries.... Wgt. 7 ozs.....

No. 1717-SH. Same but with Spread-Beam Honeycomb Lens....

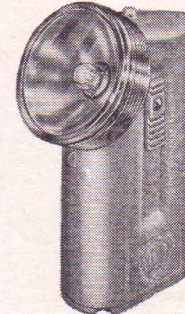

No. 1717-S

ACCESSORIES FOR JUSTRITE LANTERNS and FLASHLIGHTS

BULBS AND BATTERY FOR LANTERNS

- 20-A1 Bulb for General Use, Clear White, Mazda, 502, 5 Volts, 0.15 Amp.....
- 20-A1G Bulb, Green (Mazda 502).....
- 20-A2 Bulb, for Brighter Light, Clear White Mazda 27, 5 Volts, 0.3 Amp.....
- 20-A3 Bulb, Red (Mazda 502).....
- 20-A8 Battery, 6 Volt, 4 Cell Lantern Battery....

SUPPLY PARTS FOR "TWIN-BULB" LANTERNS (Pages Nos. 4 and 5)

- 21-A9 "Diffuser", Plastic Sleeve to Place around Bulb to Spread the Light Beam.....
- 21-A10 "Diffuser" Amber Sleeve to Place around Bulb to Color the Beam. For Fog or Signal.....
- 21-A11 "Diffuser" Green—for Green Signal.....
- 21-A12 "Diffuser" Red—for Red Signal.....
- 20-A13 Seal to Seal Cover or Globe on Lantern, Package of 100, Price per Package.....
- 20-A15 Bulb Retaining Wire to Hold Bulb in "Kick-Out" Bulb Socket (Nos. 40-S, 42-S and 44-S).....
- 21-A16 Globe, Clear, White Glass, Fire Polished. Has Molded Bayonet Locks for Fastening to Lantern Globe Clips.....
- 21-A18 Globe, "Signal Red" Glass.....
- 21-A19 Globe, Special Clear White Glass but made with Refracting Rings to Diffuse Light....
- 21-A20 Globe, Special. Transparent Plastic. Very Clear and Light Weight, Shatterproof and Practically Non-Breakable.....
- 21-A21 Globe, Special, Red Plastic.....
- 21-A22 Globe, Blue Glass.....
- 21-A24 Gasket for Globe.....
- 21-A25 Clips to Hold Globe in Place (3 Required) Each.....
- 21-A33 Latch Button and Spring Assembly for Holding Cover on Battery Case, Set Includes all Rivets, Springs, etc., Required for One Lantern, per Set.....
- 21-A39 Cover, for Battery Case (All Models).....
- 21-A57 Bracket—To Hold Lantern Upright on Wall or Side of Truck (Steel).....
- 21-A60 Holder—To Hold Lanterns with Movable Guard Against Any Surface, Allows Lantern to Rotate to Any Direction—Turn to Any Angle (Steel)

BULBS AND BATTERY FOR HEADLIGHTS AND FLASHLIGHTS

- 1701 Bulb, 3.6 Volt, .5 Amp. (Mazda 365) for Nos. 1983-AJ, 1717-S (This is also an Optional Bulb for Nos. 1904, 1994).....
- 20-A2 Bulb (Mazda 27) for Nos. 1904, 1994, 5 Volt, .3 Amp.....
- 20-09 Bulb (Mazda 263) for No. 1902, 2.4 Volt, .35 Amp.....
- 20-05 Bulb (Mazda 605) for No. 1995, 6.2 Volt, .5 Amp.....
- 20-B14 Battery (Standard Flashlight Cell) Each....

SUPPLY PARTS FOR HEADLIGHTS AND FLASHLIGHTS (Page 7)

- 1704 Glass Lens—2-1/2".....
- 1716 Honeycomb Lens—2-1/2".....
- 19-E4 Glass Lens—3" for No. 1995.....
- 1705 Lens Retaining Wire—2-1/2".....
- 19-E5 Lens Wire.... 3" for No. 1995.....
- 1706 Lens Ring for No. 1717-S.....
- 1707 Reflector for No. 1717-S.....
- 19-E6 Lens Ring for No. 1995.....
- 19-E7 Reflector for No. 1995.....
- 20-F6 Lens Ring (except Nos. 1995 and 1717-S).....
- 20-F7 Reflector (except Nos. 1995 and 1717-S).....

SUPPLY PARTS FOR LANTERNS WITH 2-1/2" REFLECTOR (Page 6)

- 1704 Glass Lens.....
- 1716 Honeycomb Lens.....
- 1705 Lens Retaining Wire.....
- 20-F6 Lens Ring.....
- 20-F7 Reflector, Silver Plated.....
- 21-A33 Latch Buttons to Hold Cover.....
- 21-A39 Cover for Battery Case.....

A Complete List of Replacement Parts Will Be Sent on Request.

JUSTRITE "POWER-FLAME" SOLDERING SETS

SELF-GENERATING COMBINATION SOLDERING IRON AND BLOW TORCH

**Burns Either Alcohol or White Gasoline
as the Fuel**

Justrite "Power-Flame" Soldering Sets consist of a self-generating Soldering Torch and several attachments which are used with it. The tool is equipped for soldering and other work by screwing the proper attachment on the end of the burner tube—at top of torch. All points and accessories are interchangeable. Any fitting may be used with any outfit.

Soldering Torch is 11" high, without attachment, 3" wide, over-all. Burns between 20 and 45 minutes on 1-1/2 ozs. of fuel. Regulating valve controls size of flame. Torch is made of brass. Handle, Base, and Regulating Valve Hand Wheel are bakelite. Each soldering set is furnished complete with wrench in a durable cardboard box.

Each torch is furnished with two complete sets of burner tips so that it can be burned with alcohol or can be used with white gasoline, as desired.

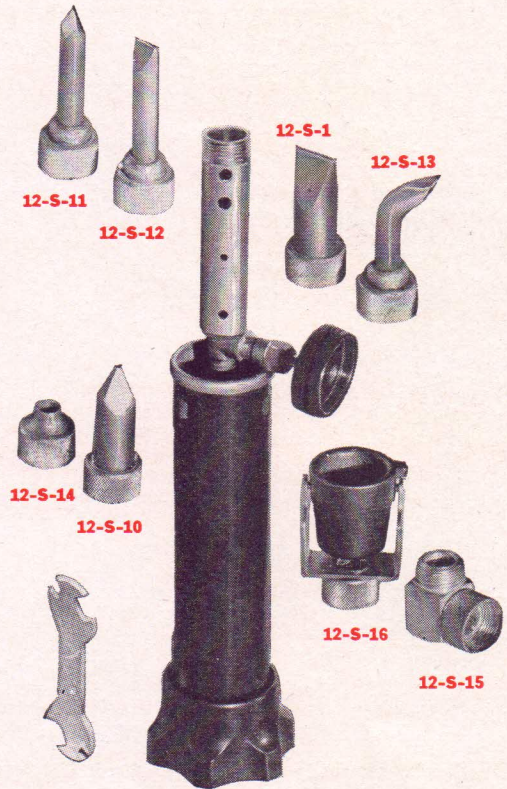

No. 1249-C Complete, All-Purpose Soldering Set

Easier to Carry—Fits Any Tool Kit Safer and Easier to Use—No Pumping

Ready for Soldering
in only a few min-
utes.

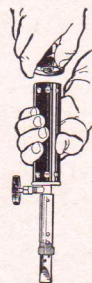

Base is removed
and torch filled.

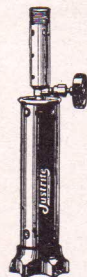

Torch is quickly
primed in upright
position.

Valve is opened
and torch lighted.

After heating, torch
can be set on side,
resting on handle.
Note Angle Con-
nection.

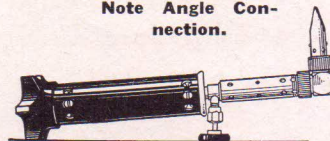

SPECIFICATIONS

No. 1249—Combination Soldering Iron and Blow Torch.... Wgt. 1-3/4 lbs....

No. 1249-R—Radio Repair and Electrician's Kit Contains Torch, No. 12-S-10 Copper Point, No. 12-S-11 Point, No. 12-S-13 Point, No. 12-S-14 Reducer and No. 12-S-16 Solder Ladle.... Wgt. 2-1/2 lbs....

No. 1249-C—Complete, All Purpose Soldering Set Contains Torch, Copper Points Nos. 12-S-1, 12-S-10, 12-S-11, 12-S-12, 12-S-13;... No. 12-S-14 Flame Reducer, No. 12-S-15 Angle Connection and No. 12-S-16 Solder Ladle.... Wgt. 2-3/4 lbs....

EXTRA SOLDERING POINTS AND ACCESSORIES

(See Illustrations Above)

12-S-1	5/8" Chisel Copper Point.....
12-S-10	5/8" Pyramid Copper Point.....
12-S-11	3/8" Pyramid Copper Point.....
12-S-12	3/8" Chisel Copper Point.....
12-S-13	45° Angle Point—3/8".....
12-S-14	Flame Reducer.....
12-S-15	Angle Connection.....
12-S-16	Solder Ladle.....
12-S-20	1" Pyramid Copper Point (not illustrated)..
12-S-21	1" Chisel Copper Point (not illustrated)....

Make up your own soldering set by selecting the points and accessories you want to use with the torch.

"POWER-FLAME" REFRIGERANT GAS LEAK DETECTORS

THREE TOOLS IN ONE

A Leak Detector for Halide Refrigerant Gases

A Soldering Iron

A Blow Torch

Convertible Either Way in Just a Few Seconds

The "Power-Flame" Leak Detector will accurately detect Freon, Carrene and other non-combustible halide gases. (Under no circumstances should any flame leak detector be used to locate leaks of combustible gas.)

To detect a leak, the flexible metal sampling hose is passed over the refrigeration system. When leaking gas is encountered it turns the flame (in the burner tube) to a bright blue-purple color. By passing the hose back and forth across the system, and observing the flame, the leak is located.

By removing the leak detector attachment, the tool is used as a blow torch. By screwing the soldering point on the end, it is equipped for soldering. (See illustrations of extra soldering points and accessories on Page 9.)

BURNS ALCOHOL OR WHITE GASOLINE

Two complete sets of burner tips are furnished with each outfit so that it can be used with anhydrous alcohol or with white gasoline (or benzine or naphtha).

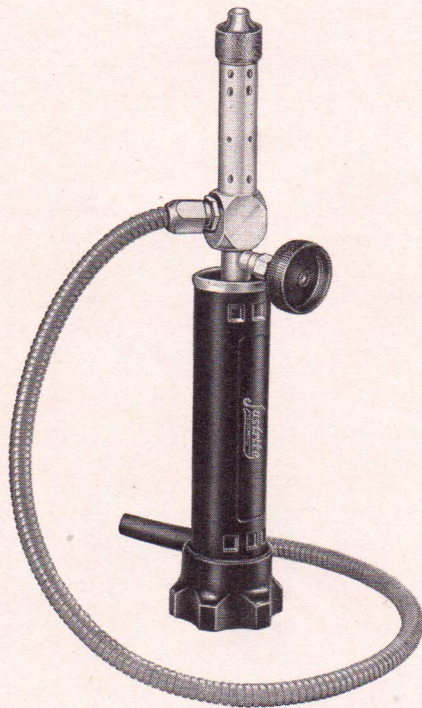

SELF-GENERATING—NO PUMPS

The Detector is easily and quickly primed and lighted without pumping. Size of flame is controlled by regulating valve hand wheel. (See illustrations for self-generating torch, Page 9.) Detector is 12" in height, 3" wide. Made of heavy gauge brass, with molded bakelite handle and base. Furnished in durable cardboard box.

No. 1240 Leak Detector Outfit, Complete. Wgt. 2 lbs. . . .

Consists of Soldering Torch with:
 No. 12-S-29 Leak Detector Attachment,
 No. 12-S-11 Soldering Point and
 No. 12-S-14 Flame Reducer.

SUPPLY PARTS FOR "POWER-FLAME" SOLDERING SETS AND LEAK DETECTOR OUTFIT (No. 1240)

- 12-S-2 Burner Tube
- 12-S-3 Burner Tip—used with Gasoline.
- 12-S-4 Base—Bakelite.
- 12-S-5 Tip Cleaner—for Gasoline Burner Tip
- 12-S-6 Handle—Bakelite.
- 12-S-7 Regulating Valve Stem—with Hand Wheel.
- 12-S-8 Filler Plug Washer.
- 12-S-9 Valve Body Complete—with Valve Stem and Wick.
- 12-S-27 Leak Detector Attachment—for Torches used with Gasoline
- 12-S-28 Flexible Sampling Hose for Leak Detector Attachment—All Types.
- 12-S-29 Leak Detector Attachment—for Torches used with Alcohol.
- 12-S-31 Burner Tip—used with Alcohol.
- 12-S-32 Venturi Tube—used with Alcohol Burner Tip.
- 12-S-33 Tip Cleaner—Alcohol Burner Tip.

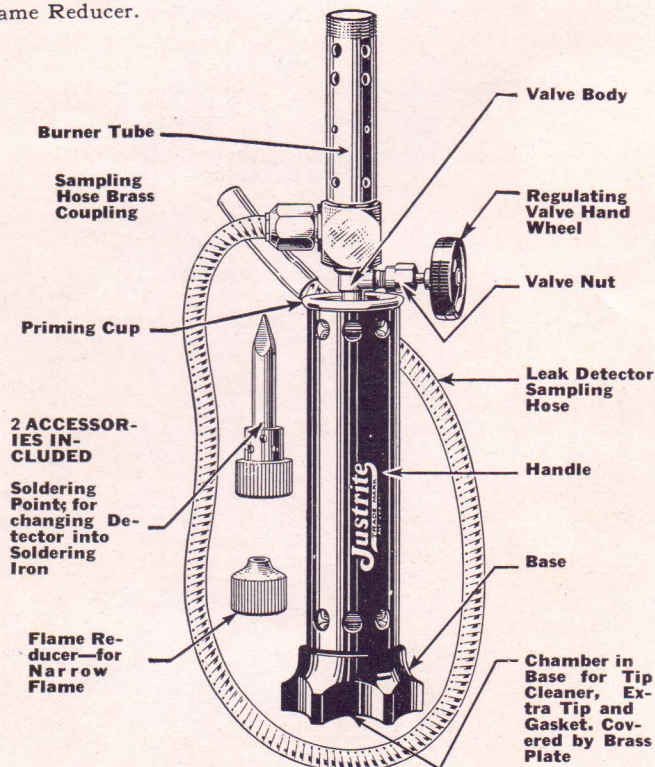

JUSTRITE CARBIDE LAMPS

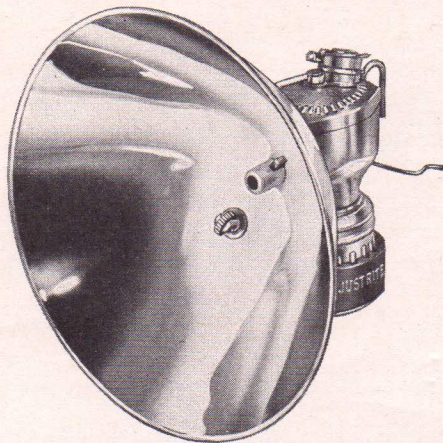

No. 2-870R—with 7" Reflector

Justrite Cap Lamps burn about 2-1/2 hours, using 2 ounces of Miner's Lamp Carbide (1/4") and water. All lamps have self-lighter attachment. Size of flame can be regulated. Air-cooled rubber grip on bottom makes lamp easy to handle.

Lamp is made of brass, highly polished and lacquered. Size: 3-3/4" high, 2" diameter at bottom.

Packed: 1 doz. in carton, weight about 6 lbs.; 6 doz. in shipping carton, weight about 42 lbs. No. 870R packed 12 in carton—21 lbs.

MINERS' CAP LAMPS Made Entirely of Brass Polished Chrome Plated Reflectors

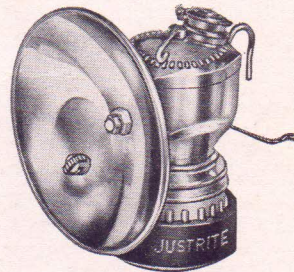

No. 2-840R

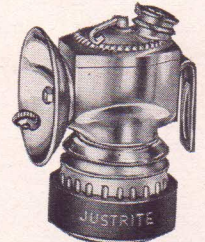

No. 2-810W

SPECIFICATIONS

Stock No.	Reflector Size	Cap Hook
2-810R	2-1/2"	Round Type—for Canvas Hat
2-811R	Same—with No. 77 Carb. Can.	
2-810W	2-1/2"	Wide (3/4") Flat Type
2-830R	3"	Round Type—for Canvas Hat
2-831R	Same—with No. 77 Carb. Can.	
2-830W	3"	Wide (3/4") Flat Type
2-840R	4"	Round Type—for Canvas Hat
2-840W	4"	Wide (3/4") Flat Type
2-870R	7"—with Flame Protector.	Round Type—for Canvas Hat

LARGE HAND LAMPS—AUTOMATIC FEED

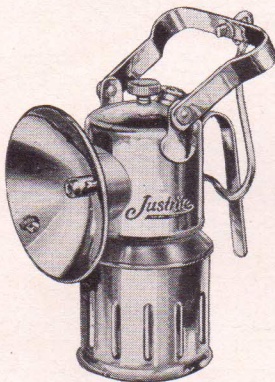

No. 2-50D
with Bail and Hook

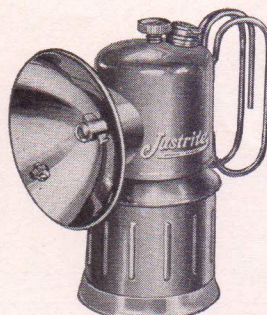

No. 2-56E
with Back Handles

EQUIPPED WITH FLAME PROTECTORS

Justrite Automatic Feed Hand Lamps are the only lamps in which the valve stem can be taken out—for cleaning—and the light will not go out.

Material: Brass, polished ("E" lamps) or Steel, tinned ("D" lamps).

Capacity: Burn 8 hours on 8 ozs. of 1/4" carbide. Bright, steady flame.

Size: Lamp is 6" high. 2-7/8" diam. at bottom.

Reflectors: 4" reflectors are heavy gauge, chrome plated. 7" size is highly polished nickel.

Packing: Nos. 50 and 56 packed 2 doz. in carton, weight about 44 lbs.; No. 57, one in carton, weight about 2-1/4 lbs.

Stock No.	Reflector Size	Finish	Handle
2-50D	4"	Steel	Bail & Hk.
2-50E	4"	Brass	Bail & Hk.
2-56D	4"	Steel	Back Hdls.
2-56E	4"	Brass	Back Hdls.
2-57D	7"	Steel	Back Hdls.
2-57E	7"	Brass	Back Hdls.



No. 2-375

MEDIUM SIZE HAND LAMPS—4-Hour Capacity

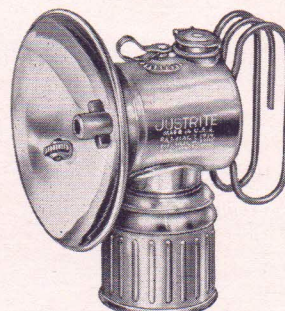

Justrite Medium Size Hand Lamps are designed to burn 4 hours on one filling of carbide and water. Lamps are made of brass, polished. Height 4-3/4", diameter 2" at bottom. Equipped with flame protector. Convenient folding back handles for carrying. Choice of two sizes of polished reflectors.

No. 2-335...with 3" reflector...
Wgt. 7 ozs....

No. 2-336...Same—with No. 77
Carbide Can....Wgt. 1 lb....

No. 2-375...with 7" Reflector...
Wgt. 1-1/4 lbs....

JUSTRITE CARBIDE HEAD LAMPS

No. 2-88B "DE LUXE" HEAD LAMP

Enclose flame lamp. Burns 8 hours. Powerful Beam. Two lenses—one is "bull's eye" lens. Has darkening door for use when total darkness is desired. Generator worn on belt—connected by rubber hose equipped with springs to prevent kinking. Removable burner tip—lamp can be used as a gas jet for interior lighting. Made of brass, painted with black lacquer. Furnished complete with Headstrap, to hold lamp on head, darkening door, and canvas belt.

No. 2-88B Head Lamp, Complete. . . . Wgt. 2-3/4 lbs. . . .

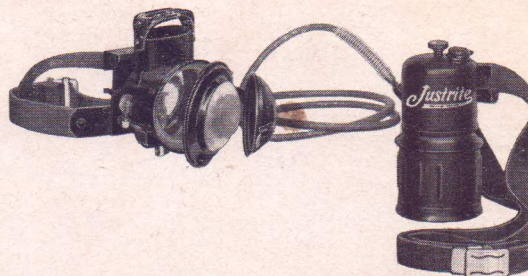

No. 2-88B

No. 2-33B HEAD LAMP

Same as No. 2-88B but with Single Lens only. Without Darkening Door, Bull's Eye Lens, or Headstrap. . . . Wgt. 2-1/2 lbs. . . .

No. 2-55A "SPOT BEAM" HEAD LAMP

Powerful beam. 7-inch polished, nickel plated reflector. Has flame protector and self-lighter attachment. Reflector and "Jewel" Burner Tip are attached directly to Canvas Cap. Cap is adjustable to any head size. Generator (brass, lacquered black) is worn on belt—connected to cap by rubber hose. Hose springs prevent kinks. 8-hour burning capacity.

No. 2-55A Head Lamp with Adjustable Cap. Wgt. 2-1/4 lbs.



No. 2-55A

SUPPLY PARTS FOR CARBIDE LAMPS

For Cap Lamps, Medium Hand and Large Hand Types (Page 11)

No.	Article
5-12	Carbide for Lamp—in 2 lb. can.
5-28	"Jewel" Burner Tip
5-52	Felt for Large Hand Lamp.
5-53	Felt Holder—for No. 5-52 Felt.
5-60	Gasket—Cap Lamps and Medium Lamps.
5-61	Gasket—Large Hand Lamps.
5-62	Felt—Cap Lamps and Medium Lamps.
5-64	Felt Holder for No. 5-62 Felt.
5-66	Burner Tip with Air Holes.
5-172	Flint.
5-177	Lighter, Complete.
5-197	Wing Nut to Hold Reflector.

SEE COMPLETE LIST OF REPLACEMENT PARTS, REFLECTORS, HEAD LAMP PARTS AND ACCESSORIES IN PRICE LIST

REPAIR OUTFIT

Assorted Repair Parts for Justrite Cap Lamps

No. 5-2 Outfit, Small Assortment. 11 dozen assorted parts packed in Cardboard Display Box. Contents:

2 doz. No. 60 Gaskets	2 doz. No. 172 Flints
2 doz. No. 62 Felts	1 doz. No. 173 Springs
1/4 doz. No. 64 Felt Holders	1/2 doz. No. 174 Screw Caps
2 doz. No. 28 Burner Tips	1/2 doz. No. 182 Hex. Nut
1/2 doz. No. 37 Tip Cleaners	1/4 doz. No. 177 Lighters complete

Shipping Weight 1-1/2 pounds

ACCESSORIES FOR JUSTRITE CARBIDE LAMPS



No. 77 Carbide Can

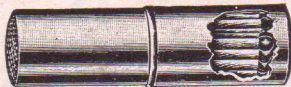

No. 75 Waterproof Match Box



No. 23 Carbide Bottle



No. 22 Wire Brush Tip Cleaner

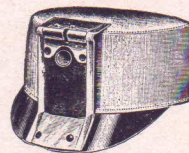

Nos. 234 and 244 Miner's Cap

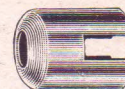

No. 180 Windproof Flame Protector

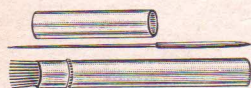

No. 245 12 Reamers in Wooden Case

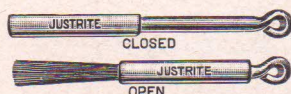

No. 37 Tip Cleaner with Sliding Cover

ACCESSORIES

Stock No.	Article
5-22	Tip Cleaner.
5-23	Carbide Bottle.
5-37	Tip Cleaner with Sliding Cover.
5-65	Lamp Clip to Hold Lamp on Hat.
5-75	Match Box—Waterproof.
5-76	Carbide Can—7 oz.
5-77	Carbide Can—10 oz.
5-150	Reamer Case—Empty, Wood Tube.
5-180	Flame Protector—Fits Wing Nut on Lamp.
5-234	Cap, Br. Canvas—Specify size.
5-244	Cap, Br. Canvas—Adjust to any size.
5-245	Reamer, in Cases.
5-248	Reamer, Gross Pkg.

JUSTRITE

PRICE LIST --- CATALOG NO. 481

Effective August 1, 1949

Refer to Catalog No. 481 for Illustrations and Descriptions. Refer also to Supplements Nos. 1, 2 and 3—below — for New Catalog additions.

Stock No.	Capacity	List Price Each
JUSTRITE SAFETY CANS (Page 2)		
1000	1 Pint	4.40
1001	Same—with screen	5.20
1010	1 Quart	4.40
1011	Same—with screen	5.20
1020	½ Gallon	5.40
1021	Same—with screen	6.20
1030	1 Gallon	5.60
1031	Same—with screen	6.40
1040	2 Gallon	6.80
1041	Same—with screen	7.60
1045	2½ Gallon	6.90
1046	Same—with screen	7.70
1050	3 Gallon	7.40
1051	Same—with screen	8.20
1060	5 Gallon	8.40
1061	Same—with screen	9.20

SCREENS FOR SAFETY CANS

1098	Screen—for 1 Pt. & 1 Qt.80
1099	Screen—for ½ Gal. thru 5 Gal. sizes80

FLEXIBLE HOSE ATTACHMENT (Page 2)

1088	Hose Attachment, Compl.	2.60
------	------------------------------	------

SAFETY FILLING CANS (Page 3)

1055	3 Gallon, complete with hose	13.60
1056	Same—with screens	15.00
1065	5 Gallon, complete with hose	15.60
1066	Same—with screens	17.00

SCREENS FOR FILLING CANS

10-7-22	Set of Two Screens	1.40
---------	--------------------------	------

JUSTRITE OILY WASTE CANS (Page 3)

WITH FOOT LEVER

9-1	6 Gallon.....	8.00
9-2	8 Gallon.....	8.80
9-3	10 Gallon.....	10.00
9-5	14 Gallon.....	11.80
9-7*	25 Gallon.....	19.80

WITHOUT FOOT LEVER

9-1A	6 Gallon.....	7.00
9-2A	8 Gallon.....	7.80
9-3A	10 Gallon.....	9.00
9-5A	14 Gallon.....	10.60
9-7A*	25 Gallon.....	17.80

*Note: Nos. 9-7 & 9-7A Waste Cans are 19 in. diam. by 20½ in. high, exclusive of legs. Approx. Ship Wgt. 26 lbs.

Stock No.	Description	List Price Each
TWIN BULB ELECTRIC LANTERNS (Page 4)		

2144-S	All-Purpose Safety Lantern	7.25
2144-SN	All-Brass Safety Lantern	8.80
2152	De-Luxe 6-volt Hand Lantern	5.45
2142-S(AB)	Standard Safety Lantern	6.45
(No. 2142-W discontinued—Replaced by No. 2152 above)		

JUSTRITE RAILROAD LANTERNS (Page 5)

2140	Twin Bulb Trainman's Lantern	4.00
2150	All Chrome Trainman's Lantern	5.60
2141-N	All Brass Trainman's Lantern	6.20
2140-W	Trainman's Lantern (Steel), with globe	4.60
(No. 2140-S discontinued—Replaced by No. 2142-SAB, Page 4)		
2171-JR	Signal Lantern with Red Fresnel Globe	6.68
2171-JW	Same—with Clear, White Fresnel Globe	6.38
2171-JB	Same—with Blue Fresnel Globe	6.68
2171-JY	Same—with Yellow Fresnel Globe	6.68
2171	Signal Lantern only, without globe	5.00

Note: These Railroad Lanterns are furnished less bulbs. Order Bulbs Nos. 20-A1 or 20-A2, Page 8, if bulbs are required.

FRESNEL GLASS GLOBES

20R70	Red Fresnel Glass	1.68
20W70	Clear, White Fresnel Glass	1.38
20B70	Blue Fresnel Glass	1.68
20Y70	Yellow Fresnel Glass	1.68

CAMP & FARM LANTERN (Page 5)

2191	Lantern, less battery	3.95
20-M10	Plastic Globe35

LANTERNS WITH 2½-INCH REFLECTOR (Page 6)

(2121 and 2121-S "Double-Header" Lanterns Discontinued. Replacement model to be announced.)

2111	Single-Head Inspector's Lantern	5.95
2101	General Utility Lantern	3.95
2107	Belt Lantern, With Belt	4.95

"FLEXIBLE LIGHT" LANTERN

1955-S	Safety Headlight—Underwriters' Approved (No. 1955 Revised)	7.95
(No. 19H55 Discontinued—Replaced by No. 1955-S, above)		
(No. 1936 Discontinued—Replaced by new No. 1958, see Supplement No. 1)		

INTERCHANGEABLE 2½-INCH LENSES

1704	Clear Glass Lens15
1716	Honeycomb, "Spread-Beam" Lens30

ELECTRIC HEADLIGHTS AND FLASHLIGHTS (Page 7)

DUAL PURPOSE HEADLIGHT-LANTERNS

1995	5-cell Headlight-Lantern, 3 in. Reflector Black Crackle Enamel & Chrome Finish.....	7.85
1987	(New) 5-cell Headlight-Lantern with 2½ in. Reflector, Gray hammered metal finish	6.25
1983	3-cell Headlight-Lantern, 2½ in. Reflector (No. 1983-AJ Revised)	4.95

Stock No. Capacity List Price Each

HEADLIGHTS AND FLASHLIGHTS

(Cont.)

ELECTRIC HEADLIGHTS AND HEADLAMPS (Page 7)		
1904	4-cell Headlight—Improved Finish	3.95
1904-S	(New) 4-cell Safety Headlight. Approved by Underwriter's Laboratories	5.45
1994	Headlamp Assembly (less battery case) 2½ in. Reflector, with switch	2.95
1996	(New) Headlamp Assembly with 3 in. Reflector without switch	3.75
1902	Mechanix Headlight (2-cell)	4.95

3-CELL APPROVED SAFETY FLASHLIGHTS (Page 8)		
1717-S	Safety Flashlight with Clear Lens	3.85
1717-SH	Same—with Honeycomb "Spread-Beam" Lens	4.00

ACCESSORIES FOR LANTERN AND FLASHLIGHTS (Page 8)

FOR ALL 6-VOLT LANTERNS		
20-A1	Bulb, Clear, For ordinary light	.15
20-A1G	Bulb, Green	.18
20-A2	Bulb, Clear, For Brighter light	.20
20-A3	Bulb, Red	.18
20-A8	Battery, standard lantern type	.88

SUPPLY PARTS FOR TWIN BULB LANTERNS		
21-A9	Diffuser to spread light beam	.05
21-A10	Diffuser, Amber, for colored beam	.05
21-A11	Diffuser, Green, for colored beam	.05
21-A12	Diffuser, Red, for colored beam	.05
20-A13	Seals for Safety Lanterns.. Per package of 100	1.25
20-A15	Bulb Retaining Wire for Safety Lanterns	.10
21-A16	Globe, Glass, Clear White	.35
21-A18	Globe, Red glass	.45
21-A19	Globe with molded rings to diffuse light	.45
21-A20	Globe, Clear plastic, Lucite	.50
21-A21	Globe, Red plastic, Lucite	.50
21-A22	Globe, Blue glass	.60
21-A24	Gasket (Rubber) For globe	.05
21-A25	Clips to hold globe to lantern. Each	.05
21-A33	Latch Buttons (For Models made before July, 1949)	.25
21-A39	Cover for Lantern Battery Case (Specify Model)	.20
21-A57	Mounting Bracket, right angle type	.60
21-A60	Rotating Holder, flat mounting type	.75

FOR HEADLIGHTS & FLASHLIGHTS		
1701	Bulb, 3.6 volt, 0.5 amp	.15
20-A2	Bulb, 5 volt, 0.3 amp	.20
20-09	Bulb, 2.4 volt, 0.35 amp	.15
20-05	Bulb, 6.0 volt, 0.5 amp (For Nos. 1995, 1987)	.20
20-B6	(New) 5 volt, 0.5 amp. For Brighter Light	.20
20-B-14	Battery, Standard flashlight cell	.12

SUPPLY PARTS FOR HEADLIGHTS & FLASHLIGHTS		
1704	Clear Glass Lens, 2½ in.	.15
1716	Honeycomb Lens for spread beam, 2½ in.	.30
19-E4	Clear Glass Lens, 3 in. for No. 1995	.20
1705	Lens Retaining Wire, 2½ in.	.10
19-E5	Lens Retaining Wire, 3 in. for No. 1995	.10
1706	Lens Ring for Model 1717-S	.20
1707	Reflector for Model 1717-S	.40
19-E6	Lens Ring, 3 in. for No. 1995	.40
19-E7	Reflector, 3 in. for No. 1995	.60
20-F6	Lens Ring, 2½ in.	.20
20-F7	Reflector, 2½ in. (except Approved Safety Lights)	.40

SUPPLY PARTS FOR LANTERNS WITH 2½ IN. REFLECTOR		
1704	Clear Glass Lens, 2½ in.	.15
1716	Honeycomb Lens for spread beam, 2½ in.	.30
1705	Lens Retaining Wire, 2½ in.	.10
20-F6	Lens Ring, 2½ in.	.20
20-F7	Reflector, 2½ in. (except Approved Safety Lights)	.40
21-A33	Latch Buttons (For Models made before August, 1949)	.25
21-A39	Cover for Lantern Battery Case (Specify Model)	.20

IMPORTANT: See Supplements Nos. 1 and 2 for additional models of flashlight and lanterns

Stock No. Description List Price Each

"POWER-FLAME" SOLDERING SETS

(Page 9)

1249	Soldering Iron and Torch	6.80
1249-R	Radio-Electricians Kit	9.80
1249-C	Complete, All Purpose Set	12.00

SOLDERING POINTS AND ACCESSORIES			
12-S-1	\$1.00	12-S-14	.25
12-S-10	1.00	12-S-15	.80
12-S-11	.80	12-S-16	.80
12-S-12	.80	12-S-20	1.50
12-S-13	.80	12-S-21	1.50

POWER-FLAME REFRIGERANT GAS LEAK DETECTOR (Page 10)		
1240	Leak Detector Outfit, Complete	8.80

SUPPLY PARTS			
12-S-2	.50	12-S-9	2.50
12-S-3	.20	12-S-27	1.60
12-S-4	.90	12-S-28	.80
12-S-5	.10	12-S-29	1.50
12-S-6	.80	12-S-31	.35
12-S-7	.70	12-S-32	.25
12-S-8	.05	12-S-33	.10

JUSTRITE CARBIDE LAMPS

Stock No.	Description	List Prices		
		Per Gr.	Per Doz.	Each
CARBIDE CAP LAMPS (Page 11)				
2-810R	2½ in. Refl. Round Hook	\$316.80	\$26.40	\$2.20
2-811R	Same—with Carbide Can	345.60	28.80	2.40
2-810W	2½ in. Refl.—Flat Hook	316.80	26.40	2.20
2-830R	3 in. Refl.—Round Hook	331.20	27.60	2.30
2-831R	Same—with Carbide Can	360.00	30.00	2.50
2-830W	3 in. Refl.—Wide Flat Hook	331.20	27.60	2.30
2-840R	4 in. Refl.—Round Hook	345.60	28.80	2.40
2-840W	4 in. Refl.—Wide Flat Hook	345.60	28.80	2.40
2-870R	7 in. Refl.—Round Hook	460.80	39.60	3.40

LARGE HAND LAMPS (Page 11)				
2-50D	4 in. Refl.—Bail and Hook, Steel	633.60	54.00	4.60
2-50E	Same—Polished Brass	662.40	58.80	5.00
2-56D	4 in. Refl.—Folding Handles, Steel	619.20	52.20	4.40
2-56E	Same—Polished Brass	648.00	55.20	4.65
2-57D	7 in. Refl.—Folding Handles, Steel	705.60	60.00	5.10
2-57E	Same—Polished Brass	748.80	63.60	5.40

MEDIUM SIZE HAND LAMPS (Page 11)				
2-335	3 in. Refl.—Folding Handles	403.20	33.60	2.80
2-336	Same—with Carbide Can	432.00	36.00	3.00
2-375	7 in. Refl.—Folding Handles	504.00	42.00	3.50

CARBIDE HEADLAMPS (Page 12)			
2-33B	Lamp—with Belt	90.00	7.50
2-55A	Lamp—with Adjustable Cap	89.40	7.45
2-88B	Lamp—with Bull's Eye Lens, Darkening Door, Headstrap & Belt	108.00	9.00

SUPPLY PARTS FOR CARBIDE LAMPS

FOR CARBIDE CAP LAMPS				
5-28	"Jewel" Burner Tip	5.76	.60	.10
5-36H5	7 in. Reflector—with Lighter	241.92	20.88	1.80
5-60	Rubber Gasket	3.88	.36	.05
5-62	Felt	2.16	.24	.05
5-63	Felt Plate for No. 62 Felt	2.70	.25	.05
5-64	Felt Holder for No. 62 Felt	6.34	.60	.10
5-65	Lamp Clip	24.00	2.16	.20
5-66	Burner Tip with Air Holes	11.52	1.00	.10
5-172	Flint	3.60	.30	.05
5-177	Lighter Complete	24.84	2.40	.25

Stock No. Description Per Gr. Per Doz. List Price Each

FOR CARBIDE CAPS LAMPS (Cont.)

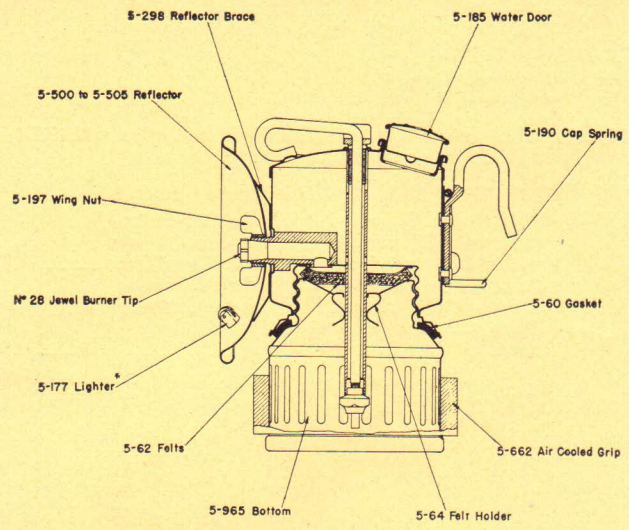

*Lighter Parts: 5-172 Flint, 5-173 Spring, 5-174 Screw Cap, 5-175 Wheel, 5-176 Fork and Nut

5-180	Flame Protector	7.90	.70	.10
5-185	Water Door	14.50	1.25	.15
5-190	Cap Spring	3.90	.35	.05
5-197	Wing Nut to hold Reflector	7.50	.65	.10
5-298	Reflector Brace	7.90	.70	.10
5-500	2 1/2 in. Reflector, with Lighter	63.36	6.00	.55
5-501	3 in. Reflector, with Lighter	69.12	6.00	.55
5-504	4 in. Reflector, with Lighter	87.82	7.68	.70
5-662	Air Cooled Rubber Grip	8.64	.96	.10
5-965	Bottom, Complete	57.60	5.04	.45

FOR LARGE HAND LAMPS

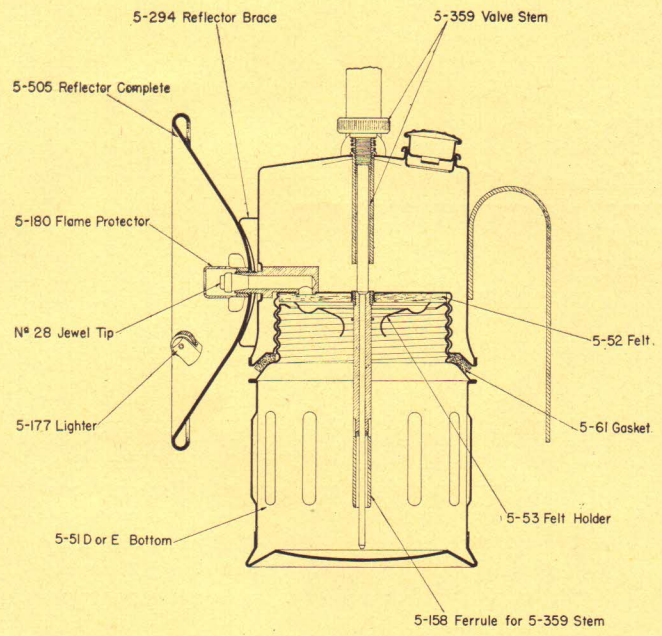

*Lighter Parts: 5-172 Flint, 5-173 Spring, 5-174 Screw Cap, 5-175 Wheel, 5-176 Fork and Nut

5-28	"Jewel" Burner Tip	5.76	.60	.10
5-36H5	7 in. Reflector, with Lighter	241.92	20.88	1.80
5-51D	Bottom for Large Steel Hand Lamp	141.12	12.00	1.10
5-51E	Bottom for Large Brass Hand Lamp	165.60	14.16	1.20
5-52	Felt	3.60	.36	.05

Stock No. Description Per Gr. Per Doz. List Price Each

5-53	Felt Holder for No. 52 Felt	12.96	1.20	.15
5-61	Rubber Gasket	8.64	.84	.10
5-158	Ferrule for No. 5-359 Stem	8.80	.75	.10
5-172	Flint	3.60	.30	.05
5-177	Lighter Complete	24.84	2.40	.25
5-180	Flame Protector	7.90	.70	.10
5-197	Wing Nut to hold Reflector	7.50	.65	.10
5-254	Reflector Brace	9.90	.85	.10
5-359	Valve Stem	36.00	3.20	.30
5-505	4 in. Reflector, with Lighter	123.84	11.52	.90

FOR MEDIUM SIZE HAND LAMPS

Medium Size Hand Lamps (Nos. 2-335, 2-336, and 2-375) use the supply parts listed at left for Justrite **Cap Lamps** except for the lamp bottom. On medium size hand lamps, use the following:

5-69	Bottom, Complete	74.88	7.20	.70
------	------------------	-------	------	-----

ACCESSORIES, REPAIR OUTFITS, CAPS, CLEANERS, ETC.

5-1	Repair Outfit for Cap Lamps—Medium Assortment of 18 1/2 dozen parts			11.60
5-2	Repair Outfit for Cap Lamps—Small Assortment of 11 dozen parts			6.00
5-12	Carbide in 2 lb. can, per can			.80
5-23	Carbide Bottle (Empty) 1 lb. size	44.64	3.96	.35
5-22	Tip Cleaner	18.72	1.80	.20
5-37	Tip Cleaner with Sliding Cover	25.92	2.28	.20
5-65	Lamp Clip	24.00	2.16	.20
5-75	Match Box — Waterproof	24.48	2.40	.25
5-77	Carbide Pocket Can (Empty) 10 oz.	30.24	2.76	.25
5-150	Reamer Case—Empty wood tube	5.26	.45	.05
5-234	Canvas Cap for Cap Lamps with "R" style hook. Various sizes	102.68	9.00	1.00
5-244	Same as cap above but adjustable. Fits all head sizes	143.84	12.00	1.00
5-245	Reamer—in cases of 12	5.50	.50	.05
5-248	Reamer (Std. pkg., one gross)	4.20	.40	.05

FLINTS AND LIGHTER PARTS FOR CAP LAMPS AND HAND LAMPS

5-172	Flint	3.60	.30	.05
5-172-2	Flints—packed 2 in capsule (Per quantity of flints)	3.40	.30	.05
5-173	Spring for Lighter	1.80	.20	.05
5-174	Screw Cap for Lighter	3.20	.35	.05
5-175	Wheel for Lighter	7.60	.70	.10
5-176	Fork & Nut for Lighter	12.60	1.10	.15
5-177	Lighter Complete	24.84	2.40	.25
5-182	Hex Nut for Lighter	3.00	.30	.05

SUPPLY PARTS FOR HEAD LAMPS—Nos. 2-33B & 2-88B (Parts marked * fit No. 2-55A Head Lamp also)

5-52	*Felt Packing	3.60	.36	.05
5-53	*Felt Holder	12.96	1.20	.15
5-61	*Gasket	8.64	.84	.10
5-67	Burner Tip	43.20	3.60	.30
5-158	*Ferrule for Valve Stem	8.80	.75	.10
5-172	*Flint	3.60	.30	.05
5-177	*Lighter, complete	24.84	2.40	.25
5-359	*Valve Stem	36.00	3.20	.30
5-33-A-1	*Generator	48.00	4.00	.40
5-33-A-2	*Bottom	15.00	1.25	.15
5-33-A-8	*Rubber Hose	7.20	.60	.05
5-33-A-9	*Belt	7.20	.60	.05
5-33-A-11	*Hose Pins, per pair	1.80	.15	.02
5-88-A-5	3 in. Lens	1.80	.15	.02
5-88-A-7	Head Strap	7.20	.60	.05
5-88-A-8	2 1/2 in. Bull's Eye Lens (for No. 2-88B)	4.80	.40	.05
5-88-A-10	Bull's Eye Lens & Door (for No. 2-88B)	10.80	.90	.10
5-88-A-11	Darkening Door (for No. 2-88B)	4.80	.40	.05
5-88-A-16	Lens Wire (3 in.)	1.20	.10	.02
5-33-B-1	Headlamp for No. 2-33B	48.00	4.00	.40
5-88-B-1	Headlamp for No. 2-88B	60.00	5.00	.50
5-88-B-3	Reflector	3.60	.30	.05
5-88-B-4	Tube and Tip	7.20	.60	.05

Stock No. Capacity List Price Each

HEADLIGHTS AND FLASHLIGHTS

(Cont.)

ELECTRIC HEADLIGHTS AND HEADLAMPS (Page 7)		
1904	4-cell Headlight—Improved Finish	3.95
1904-S	(New) 4-cell Safety Headlight. Approved by Underwriter's Laboratories	5.45
1994	Headlamp Assembly (less battery case) 2½ in. Reflector, with switch	2.95
1996	(New) Headlamp Assembly with 3 in. Reflector without switch	3.75
1902	Mechanix Headlight (2-cell)	4.95

3-CELL APPROVED SAFETY FLASHLIGHTS (Page 8)		
1717-S	Safety Flashlight with Clear Lens	3.85
1717-SH	Same—with Honeycomb "Spread-Beam" Lens	4.00

ACCESSORIES FOR LANTERN AND FLASHLIGHTS (Page 8)

FOR ALL 6-VOLT LANTERNS		
20-A1	Bulb, Clear, For ordinary light	.15
20-A1G	Bulb, Green	.18
20-A2	Bulb, Clear, For Brighter light	.20
20-A3	Bulb, Red	.18
20-A8	Battery, standard lantern type	.88

SUPPLY PARTS FOR TWIN BULB LANTERNS		
21-A9	Diffuser to spread light beam	.05
21-A10	Diffuser, Amber, for colored beam	.05
21-A11	Diffuser, Green, for colored beam	.05
21-A12	Diffuser, Red, for colored beam	.05
20-A13	Seals for Safety Lanterns..	

	Per package of 100	1.25
20-A15	Bulb Retaining Wire for Safety Lanterns	.10
21-A16	Globe, Glass, Clear White	.35
21-A18	Globe, Red glass	.45
21-A19	Globe with molded rings to diffuse light	.45
21-A20	Globe, Clear plastic, Lucite	.50
21-A21	Globe, Red plastic, Lucite	.50
21-A22	Globe, Blue glass	.60
21-A24	Gasket (Rubber) For globe	.05
21-A25	Clips to hold globe to lantern. Each	.05
21-A33	Latch Buttons (For Models made before July, 1949)	.25
21-A39	Cover for Lantern Battery Case (Specify Model)	.20
21-A57	Mounting Bracket, right angle type	.60
21-A60	Rotating Holder, flat mounting type	.75

FOR HEADLIGHTS & FLASHLIGHTS		
1701	Bulb, 3.6 volt, 0.5 amp	.15
20-A2	Bulb, 5 volt, 0.3 amp	.20
20-09	Bulb, 2.4 volt, 0.35 amp	.15
20-05	Bulb, 6.0 volt, 0.5 amp (For Nos. 1995, 1987)	.20
20-B6	(New) 5 volt, 0.5 amp. For Brighter Light	.20
20-B-14	Battery, Standard flashlight cell	.12

SUPPLY PARTS FOR HEADLIGHTS & FLASHLIGHTS		
1704	Clear Glass Lens, 2½ in.	.15
1716	Honeycomb Lens for spread beam, 2½ in.	.30
19-E4	Clear Glass Lens, 3 in. for No. 1995	.20
1705	Lens Retaining Wire, 2½ in.	.10
19-E5	Lens Retaining Wire, 3 in. for No. 1995	.10
1706	Lens Ring for Model 1717-S	.20
1707	Reflector for Model 1717-S	.40
19-E6	Lens Ring, 3 in. for No. 1995	.40
19-E7	Reflector, 3 in. for No. 1995	.60
20-F6	Lens Ring, 2½ in.	.20
20-F7	Reflector, 2½ in. (except Approved Safety Lights)	.40

SUPPLY PARTS FOR LANTERNS WITH 2½ IN. REFLECTOR		
1704	Clear Glass Lens, 2½ in.	.15
1716	Honeycomb Lens for spread beam, 2½ in.	.30
1705	Lens Retaining Wire, 2½ in.	.10
20-F6	Lens Ring, 2½ in.	.20
20-F7	Reflector, 2½ in. (except Approved Safety Lights)	.40
21-A33	Latch Buttons (For Models made before August, 1949)	.25
21-A39	Cover for Lantern Battery Case (Specify Model)	.20

IMPORTANT: See Supplements Nos. 1 and 2 for additional models of flashlight and lanterns

Stock No. Description List Price Each

"POWER-FLAME" SOLDERING SETS

(Page 9)

1249	Soldering Iron and Torch	6.80
1249-R	Radio-Electricians Kit	9.80
1249-C	Complete, All Purpose Set	12.00

SOLDERING POINTS AND ACCESSORIES			
12-S-1	\$1.00	12-S-14	.25
12-S-10	1.00	12-S-15	.80
12-S-11	.80	12-S-16	.80
12-S-12	.80	12-S-20	1.50
12-S-13	.80	12-S-21	1.50

POWER-FLAME REFRIGERANT GAS LEAK DETECTOR (Page 10)		
1240	Leak Detector Outfit, Complete	8.80

SUPPLY PARTS			
12-S-2	.50	12-S-9	2.50
12-S-3	.20	12-S-27	1.60
12-S-4	.90	12-S-28	.80
12-S-5	.10	12-S-29	1.50
12-S-6	.80	12-S-31	.35
12-S-7	.70	12-S-32	.25
12-S-8	.05	12-S-33	.10

JUSTRITE CARBIDE LAMPS

Stock No.	Description	List Prices		
		Per Gr.	Per Doz.	Each
CARBIDE CAP LAMPS (Page 11)				
2-810R	2½ in. Refl. Round Hook	\$316.80	\$26.40	\$2.20
2-811R	Same—with Carbide Can	345.60	28.80	2.40
2-810W	2½ in. Refl.—Flat Hook	316.80	26.40	2.20
2-830R	3 in. Refl.—Round Hook	331.20	27.60	2.30
2-831R	Same—with Carbide Can	360.00	30.00	2.50
2-830W	3 in. Refl.—Wide Flat Hook	331.20	27.60	2.30
2-840R	4 in. Refl.—Round Hook	345.60	28.80	2.40
2-840W	4 in. Refl.—Wide Flat Hook	345.60	28.80	2.40
2-870R	7 in. Refl.—Round Hook	460.80	39.60	3.40

LARGE HAND LAMPS (Page 11)				
2-50D	4 in. Refl.—Bail and Hook, Steel	633.60	54.00	4.60
2-50E	Same—Polished Brass	662.40	58.80	5.00
2-56D	4 in. Refl.—Folding Handles, Steel	619.20	52.20	4.40
2-56E	Same—Polished Brass	648.00	55.20	4.65
2-57D	7 in. Refl.—Folding Handles, Steel	705.60	60.00	5.10
2-57E	Same—Polished Brass	748.80	63.60	5.40

MEDIUM SIZE HAND LAMPS (Page 11)				
2-335	3 in. Refl.—Folding Handles	403.20	33.60	2.80
2-336	Same—with Carbide Can	432.00	36.00	3.00
2-375	7 in. Refl.—Folding Handles	504.00	42.00	3.50

CARBIDE HEADLAMPS (Page 12)				
2-33B	Lamp—with Belt		90.00	7.50
2-55A	Lamp—with Adjustable Cap		89.40	7.45
2-88B	Lamp—with Bull's Eye Lens, Darkening Door, Headstrap & Belt		108.00	9.00

SUPPLY PARTS FOR CARBIDE LAMPS

FOR CARBIDE CAP LAMPS				
5-28	"Jewel" Burner Tip	5.76	.60	.10
5-36H5	7 in. Reflector—with Lighter	241.92	20.88	1.80
5-60	Rubber Gasket	3.88	.36	.05
5-62	Felt	2.16	.24	.05
5-63	Felt Plate for No. 62 Felt	2.70	.25	.05
5-64	Felt Holder for No. 62 Felt	6.34	.60	.10
5-65	Lamp Clip	24.00	2.16	.20
5-66	Burner Tip with Air Holes	11.52	1.00	.10
5-172	Flint	3.60	.30	.05
5-177	Lighter Complete	24.84	2.40	.25

IMPORTANT — NEW ADDITIONS TO CATALOG NO. 481

SUPPLEMENT NO. 1

Catalog No. 481 — Price List of August 1, 1949

NEW JUSTRITE "YELLOW-FLASH" LIGHTS

The entirely new design in portable lights. The most powerful of their type made. Use 8 standard flashlight batteries with 9.6 or 9.9 volt bulbs. Convertible for use with a standard lantern battery. Available in three models.

No. 2108	"Yellow-Flash", 8-cell Flashlight, with Folding Handles. List Price Each	3.95	EXTRA BULBS FOR 8-CELL LIGHTS (Packed in Tubes)	
No. 2198	"Yellow-Flash", 8-cell Hand Lantern with Twin Bulbs. List Price Each	4.45	No. 20-96	Bulb Tube. Contains 2 Mazda 965 Bulbs (9.6 volt, 0.5 amp.). For brightest beam with 8-battery circuit. List Price Per Tube.....
No. 1958	"Yellow-Flash," 8-cell Headlight, with Elastic Headband. List Price Each	4.95	No. 20-93	Bulb Tube. Contains 3 Mazda 993 Bulbs (9.9 volt, 0.3 amp.). For longer battery life (with less intensity) in 8-battery circuits. List Price Per Tube
				.35
				.55

Refer to Bulletin YF-1 for Illustrations and Description

SUPPLEMENT NO. 2

Catalog No. 481 — Price List of August 1, 1949

NEW JUSTRITE SAFETY LIGHTS

The following new models are now in preparation—available for Fall Delivery.

No. 2101-S	8-cell Safety Flashlight. For 8 flashlight batteries and 9.9 volt bulb. List Price Each	4.95	No. 2166-S	12-Volt Safety Lantern. Uses two lantern batteries, 3 in. Reflector. List Price Each	8.35
No. 2144-S	Revised. All-Purpose Safety Lantern. Uses 8 Standard Flashlight Batteries or Lantern Battery. List Price Each	7.25	No. 2175-S	Safety Flasher Lantern. Gives "flashing" beam or steady warning light. Uses one standard lantern battery. List Price Each	9.95

SUPPLEMENT NO. 3

Catalog No. 481 — Price List of August 1, 1949

JUSTRITE "TRIGGER-ACTION" FIRE EXTINGUISHER

Model No. 1610 — 1 Quart Size

A great new development in approved hand extinguishers. Stored pressure, vaporizing liquid type — "Trigger Action". No pumps or wheels to operate. Instantaneous discharge by pressing the trigger. 30 ft. stream of fire-killing chemical. Approved and labeled by Underwriter's Laboratories, Inc. Complies with regulations of I.C.C. and U.S. Bureau of Steamboat and Navigation. Dependable and easy to operate. Air-tight construction holds pressure indefinitely. Prevents corrosion. Air gauge shows if extinguisher is in

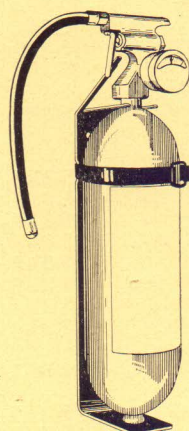

operating condition. Easily filled. Air pressure can be added from "Filling Station" air hose. Factory "Servicing" not required. Has only one moving part. Furnished complete with Wall Bracket, fully charged ready to use. Packed one per carton, Wgt. 8 lbs., 6 in standard shipping package, Wgt. 50 lbs. No. 1610 Justrite "Trigger-Action" Fire Extinguisher, 1 Quart Capacity, List Price, Each\$18.00

THE JUSTRITE
"Trigger-Action" FIRE EXTINGUISHER
MODEL 1610



- The entirely new stored pressure, vaporizing liquid extinguisher. 1 Qt. capacity.
- Approved and Labeled by Underwriters' Laboratories, Inc.
- Trigger release—30 Ft. Stream.
- Non-corrosive, sealed system.
- Easy to refill—use Justrite fluid and ordinary air.
- Air Pressure gauge shows condition at a glance.
- Only one moving part.

JUSTRITE MANUFACTURING COMPANY
CHICAGO 14, ILLINOIS, U. S. A.

KEEP THIS END UP
1. PLACE CORD AROUND NECK
2. GRASP HANDLE
3. AIM HOSE AT BASE OF FIRE
4. PULL TRIGGER

JUSTRITE

**STORED PRESSURE
FIRE EXTINGUISHER**
TESTED AT 450 LBS.
ORIGINAL CONTENTS NOT LESS THAN 25%
CARBON TETRACHLORIDE

RECHARGE IMMEDIATELY AFTER USE

MAINTENANCE
CHECK PRESSURE AND WEIGHT EVERY 6 MONTHS.
SHOULD WEIGHT BE BELOW 25% OR PRESSURE
BELOW 90 LBS. RECHARGE EXTINGUISHER.

TO RECHARGE
INVERT. PULL TRIGGER TO RELEASE PRESSURE.
REMOVE BOTTOM PLUG. REFILL WITH 1 QT. JUSTRITE FLUID.
SCREW PLUG IN TIGHTLY. REATTACH LEAD HOSE.
IF WORN, REMOVE HOSE. PRESS OUTLET TO AIR
HOSE AT ANY GASOLINE STATION. PULL TRIGGER
CHARGE TO 100 LBS. RELEASE TRIGGER BEFORE
REMOVING AIR HOSE. SHAKE EXTINGUISHER AND
MORE AIR UNTIL GAUGE REMAINS AT 100 LBS.
ATTACH HOSE.

WARNING
EXTINGUISH FIRES PROMPTLY AND AVOID EXPOSURE
TO SMOKE AND FUMES.

JUSTRITE MFG. CO.
CHICAGO 14, ILL. U. S. A.

Underwriters' Laboratories, Inc.
INSPECTED
SAFE, EFFECTIVE HAND FIRE EXTINGUISHER
TESTED AND APPROVED BY U. S. DEPT. OF COMMERCE
NO. M-9-194

JUSTRITE

Yellow-Flash

LIGHTS

CONVERTIBLE!

Exclusive 2-Way Circuit takes either 8 cells or one lantern battery.

Yellow-Flash Flashlight

POWERFUL!

Up to 7079 Beam Candle Power from 8 regular flashlight cells.

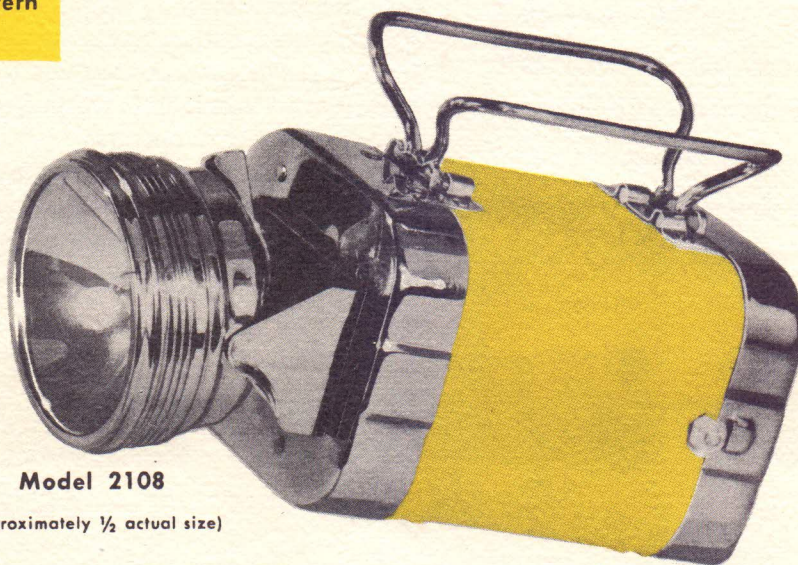

Model 2108

(Approximately 1/2 actual size)

AMERICA'S MOST POWERFUL

Yellow-Flash Headlight

Yellow-Flash Lantern

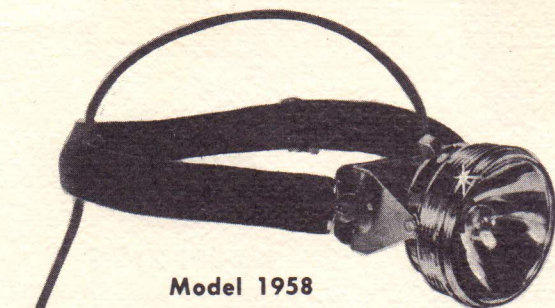

Model 1958



(Approximately 1/3 actual size)

FOR 8 FLASHLIGHT CELLS

(Approximately 1/3 actual size)

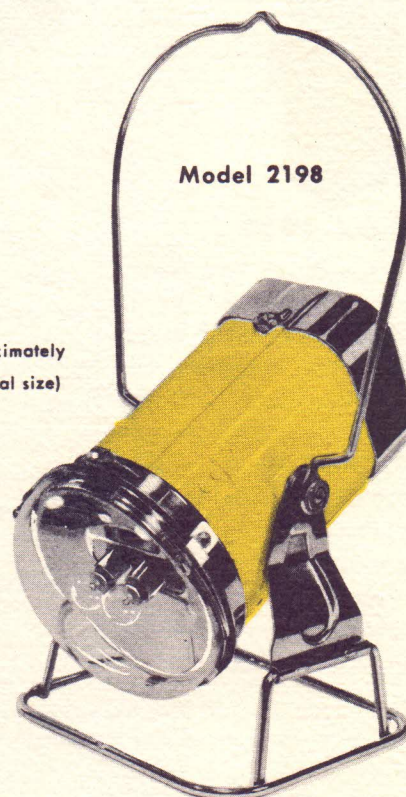

Model 2198

YOU'LL SEE MORE—BE SURE—STAY SAFE IN THE DARK WITH THESE "DOUBLE POWER" *Yellow-Flash* LIGHTS

YELLOW-FLASH Lights are the most powerful lights made for use with the popular size dry cells. Using 8 regular flashlight cells which are available everywhere, they give a "spot" beam (measuring as much as 7049 Candle Power) which can be seen at very great distances. . . . A beam more than twice as powerful as the ordinary camp or fishing lantern!

Because of the exclusive "Square-Case" design, a "**YELLOW-FLASH**" Light is compact, easy to handle and is no larger in size than an ordinary lantern.

"HIGH-POWERED" OR "THRIFTY" TWO-WAY BATTERY CIRCUIT —

For maximum power, 8 cells are used with a powerful, high voltage bulb (No. 965 or 993). To get battery economy—long burning life with less intensity—a lantern battery can be substituted. No changes are required in the case—just put in the 6-volt battery, substitute a 5 volt bulb in the socket and the "Thrifty Circuit" is ready to operate.

For added convenience the "**YELLOW FLASH**" design is made available in the three separate types described below. Each is ruggedly built of finest materials and finished in brilliant yellow enamel and bright nickel plating.



Headlight



Model 1958

For all purposes requiring *Both Hands Free*. Ideal for camp chores, as a "work" light, etc. Fastens around head or hat on adjustable elastic headband. Has sponge rubber headpad. Strong belt loop on side holds case in position on ordinary belt. Has 2½" highly polished reflector. Switch located on headpiece in "handiest" position. Weatherproof, plastic connecting cord. Furnished with two bulbs (8-cell type), less batteries.

No. 1958 Headlight. \$4.95 Ea.

Ship. Wgt. 1½ lbs.



Flashlight

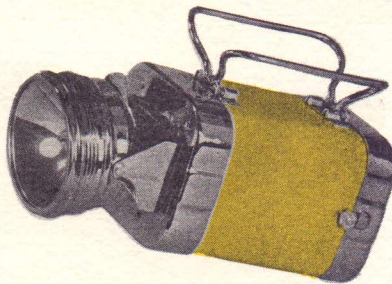

Model 2108

For all "flashlight" purposes. More convenient. Carries easily or stands firmly on square base. Headpiece tilts to any angle. Carrying handles fold against case when not in use. Only 8½" long, 2⅞" wide—fits glove compartment, tackle box or tool kit. Has 2½" highly polished reflector. Furnished with two bulbs (for 8-cell operation), less batteries.

No. 2108 Flashlight. \$3.95 Ea.

Ship. Wgt. 1¼ lbs.



Lantern

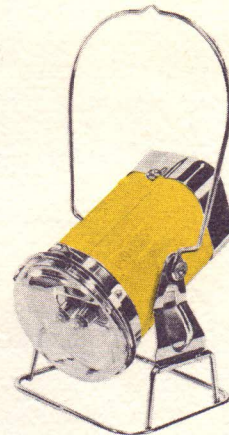

Model 2198

For Farm, Camp, or Boat. Has exclusive "Twin-Bulb" reflector design with two bulbs mounted on a sliding plate. Either bulb gives both a strong "spot" beam *plus* short range diffused light. Bulbs interchanged instantly by moving the switch. Has large bail for carrying or hanging. Will stand on guard-base with light directed at any angle desired. Overall size 11½" x 6½" x 5". 3¾" polished reflector. Glass globe (lens) covers entire reflector. Furnished with 2 bulbs (8-cell type), less batteries.

No. 2198 Lantern. \$4.45 Ea.

Ship. Wgt. 2 lbs.

No. 21-A60 Rotating holder for Yellow-Flash Lantern. Holds lantern firmly to wall, truck or deck and allows it to rotate any direction — tilt to any angle. Lantern "snaps" in or out easily. \$.75 Ea.

Ship. Wgt. 1 lb.